



<https://doi.org/10.11646/megataxa.6.2.3>

<https://zoobank.org/urn:lsid:zoobank.org:pub:0A8F7E38-8D11-44EE-8840-F8DE241306D0>

Revision of *Ischnopelta* Stål, 1868 with the description of twenty new species (Hemiptera: Pentatomidae: Discocephalinae)

PEDRO ROSSO¹ & LUIZ ALEXANDRE CAMPOS^{2,3}

¹ Instituto Federal de Santa Catarina, Campus Criciúma, Rodovia SC 443, 845, Criciúma, SC, Brazil, 88813-600.

✉ pedro.rosso@ifsc.edu.br; <https://orcid.org/0000-0002-4698-1938>

² Universidade Federal do Rio Grande do Sul, Departamento de Zoologia, Av. Bento Gonçalves 9500, Porto Alegre, RS, Brazil 91501-970.

✉ luiz.campos@ufrgs.br; <https://orcid.org/0000-0001-5414-8746>

³ Corresponding author.

Abstract

Ischnopelta Stål, 1868 is a Discocephalini genus with three known species, *I. scutellata* (Signoret, 1851), *I. oblonga* (Fieber, 1851), and *I. luteicornis* (Walker, 1867), and distribution restricted to South America. The examination of 284 specimens from several localities in Venezuela, Brazil, Bolivia, Argentina, and Paraguay, revealed the existence of new species. Measurements of 24 morphometric parameters were taken using stereomicroscope and tpsDig2 version 2.16 from images captured with an MShot MD50 camera coupled to a Techno RZ stereomicroscope and edited in MShot DIS version 1.1. The genitalia of both sexes was dissected upon specimen availability, digested in KOH 10%, dehydrated in ethanol 70%, stained in Congo red (when needed), and preserved in liquid glycerin. Photographs were made in a Nikon AZ100M stereomicroscope, and a focus stacking procedure was done with Nikon NIS-Elements Ar Microscope Imaging Software. Drawings were produced over the images with a vectorial image processor. In this work *Ischnopelta* is revised, *I. scutellata* and *I. luteicornis* are redescribed, and keys to males and females of the species are proposed. We describe 20 new species: *I. alalonga* sp. n., *I. anangulata* sp. n., *I. bechyneorum* sp. n., *I. confusa* sp. n., *I. coralinae* sp. n., *I. cordiformis* sp. n., *I. crassula* sp. n., *I. cristulata* sp. n., *I. cylindrata* sp. n., *I. guarani* sp. n., *I. impunctata* sp. n., *I. magna* sp. n., *I. marginella* sp. n., *I. montana* sp. n., *I. paiagua* sp. n., *I. parvula* sp. n., *I. pellucidula* sp. n., *I. ruckesi* sp. n., *I. vellozia* sp. n., and *I. wigodinskyi* sp. n.. We were unable to locate the syntypes of *I. oblonga* (Fieber, 1851) and the species is treated here as incertae sedis.

Key words: *Discocephala*, Discocephalini, Heteroptera, Neotropical

Introduction

The Discocephalinae Fieber, 1860 (Pentatomidae) are distributed mainly in the Neotropical Region with a few

species recorded in the southern Nearctic (Grazia & Schwertner 2011, Grazia *et al.* 2015, Garbelotto *et al.* 2018). The species in the subfamily are small to medium sized, brown to black (Schuh & Slater 1995, Grazia *et al.* 1999), and classified in two tribes, Discocephalini Fieber, 1860 with 46 genera (Rider *et al.* 2018), and Ochlerini Rolston, 1981 with 37 genera (Roell & Campos 2019). The species in the nominal subfamily are recognized by the labium usually inserted on or posterior to an imaginary transversal line drawn at the anterior limit of the eyes, and by the abdominal trichobothria lateral to an imaginary line connecting the spiracles (Rolston & McDonald 1979, Rolston 1981, Roell & Campos 2015, Garbelotto 2015). Within Discocephalini, there are 14 genera in the so-called “broadheaded discocephalines” group characterized by the interocular distance greater than the length of the head (Ruckes 1966, Becker 1977, Rolston 1990). One of these 14 genera is *Ischnopelta* Stål, 1868.

Ischnopelta was proposed as a subgenus of *Discocephala* Laporte, 1832 (Stål 1868) to include the South American species *Discocephala scutellata* Signoret, 1851 (Venezuela) and *Discocephala ovata* Signoret, 1851 (Brazil). In Stål’s (1868) key *Ischnopelta* is distinguished by the relatively long scutellum and coria, the uniformly convex margin of the mandibular plates, and the subequal distance between ocelli and between each ocellum and the respective eye. *Discocephala ovata* was later synonymized under *Discocephala scutellata* (Stål 1872). Berg (1891) raised *Ischnopelta* to genus and extended the occurrence of *I. scutellata* to Misiones (Argentina) and Paraguay. Kirkaldy (1909) followed Berg’s classification and transferred *Discocephala oblonga* Fieber, 1851 to *Ischnopelta*. Rolston (1990) included *Ischnopelta* in the key to the “broadheaded discocephalines” genera, providing a brief diagnosis of the genus. Rolston (1990) differentiated *Ischnopelta* from other genera by the same characteristics listed by Stål (1868), plus the shape of the anterior margin of the male urosternite VII, and the shape of the parameres. The most recent reference to *Ischnopelta* is that of Becker & Grazia (1992), who

transferred *Discocephala luteicornis* Walker, 1867 to the former genus.

In this work, we revise *Ischnopelta*, redescribe *I. scutellata* and *I. luteicornis*, describe 20 new species, and provide a key to the species of the genus.

Material and Methods

A total of 284 specimens were examined, loaned from the following collections: AMNH—American Museum of Natural History, New York, New York, USA; CAS—California Academy of Sciences, San Francisco, California, USA; DZUP—Museu de Entomologia Pe. Jesus Santiago Moure, Universidade Federal do Paraná, Curitiba, Paraná, Brazil; FIOC—Fundação Instituto Oswaldo Cruz, Rio de Janeiro, Rio de Janeiro, Brazil; JEE—J. E. Eger (Private Collection), Tampa, Florida, EUA; MACN—Museo Argentino de Ciencias Naturales Bernardino Rivadavia, Buenos Aires, Argentina; MCNZ—Museu de Ciências Naturais da Fundação Zoobotânica do Rio Grande do Sul, Porto Alegre, Rio Grande do Sul, Brazil; MIZA—Museo del Instituto de Zoología Agrícola “Francisco Fernández Yépez”, Maracay, Venezuela; MLPA—Museo de La Plata, Universidade Nacional de La Plata, La Plata, Argentina; MNRJ—Museu Nacional, Universidade Federal do Rio de Janeiro, Rio de Janeiro, Rio de Janeiro, Brazil;

MPEG—Museu Paraense Emilio Goeldi, Belém, Pará, Brazil; MZSP—Museu de Zoologia da Universidade de São Paulo, São Paulo, São Paulo, Brazil; UEMA—Universidade Estadual do Maranhão, São Luiz, Maranhão, Brazil; UFRG—Departamento de Zoologia, Universidade Federal do Rio Grande do Sul, Porto Alegre, Rio Grande do Sul, Brazil; USNM—National Museum of Natural History, Washington D.C., USA; UFPA—Universidade Federal do Pará, Belém, Pará, Brazil; UNIFESP—Laboratório Heteroptera, Universidade Federal de São Paulo, Diadema, São Paulo, Brazil.

We were unable to locate the holotype of *I. scutellata* in the Muséum National d’Histoire Naturelle (MNHN), so the specimens were identified by comparisons with the information in literature and with a homotype identified by H. Ruckes in 1961. We were also unable to find the syntypes of *I. oblonga* in the Naturhistorisches Museum Wien (NHMW) nor in the Museum für Naturkunde Berlin (ZMHB). Thus, we considered *I. oblonga* as *incertae sedis* due to the impossibility of undoubtful identification based only in the literature. We used images of the syntypes of *I. luteicornis* deposited in the Natural History Museum, London (NHM) to redescribe the species and identify the available specimens.

Measurements of antennae and labium were obtained with stereomicroscope. Further measurements were made in tpsDig2 version 2.16 (Rohlf 2010) from

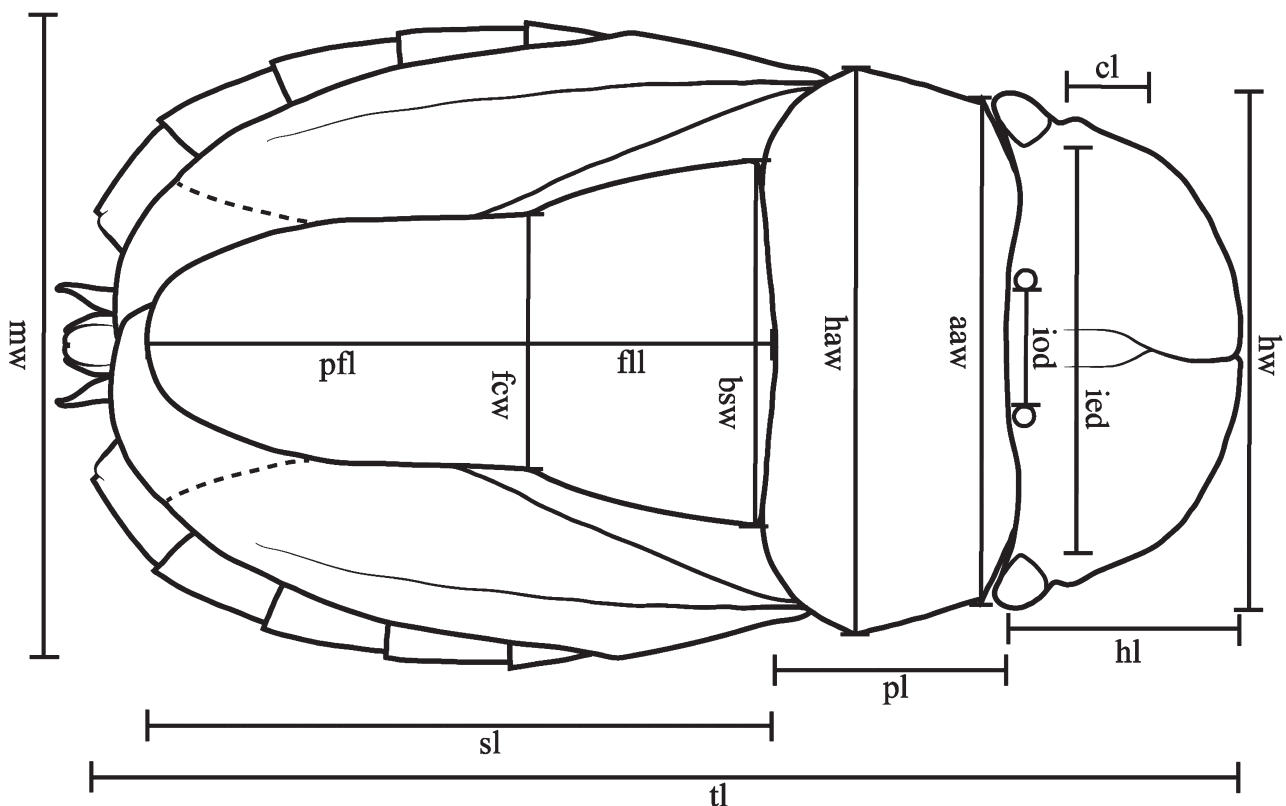

FIGURE 1. Measurements performed on specimens. Abbreviations: tl, total length; mw, maximum width (at the sternite III level); hl, head length; cl, clypeus length; hw, head width; iod, interocellar distance; ied, interocular distance; pl, pronotum length; haw, pronotum width at the level of humeral angles; aaw, pronotum width at the level of anterolateral angles; sl, scutellum length; fl, frenal lobe length; pfl, post-frenal lobe length; bsw, basal scutellum width; few, scutellum width at the level of frenal constriction.

images captured with an MShot MD50 camera coupled to a Techno RZ stereomicroscope and edited in MShot DIS version 1.1 (Micro-Shot Tecnology Co. 2010) (Fig. 1). Male and female, when available, were dissected for examination of the internal genital structures. The removed parts (female abdomen and male pygophore) were boiled in KOH 10% aqueous solution to soften the cuticle and washed in tap water. The internal parts were removed with forceps, dehydrated in ethanol 70%, stained in Congo red (when needed), and preserved in liquid glycerin. Images of the specimens' body and external and internal genital structures were made in a Nikon AZ100M stereomicroscope, and a focus stacking procedure was done with Nikon NIS-Elements Ar Microscope Imaging Software. Drawings were produced over the images with a vectorial image processor. We adopted the terminology of Baker (1931), Dupuis (1970), Garbelotto *et al.* (2013), and Zhou & Rédei (2020) for genital structures; of Ruckes (1966), Becker (1977), Becker & Grazia (1995), and Garbelotto *et al.* (2013) for Discocephalinae structures; and of Kment & Vilimová (2010) and Barão *et al.* (2016) for the external scent efferent system.

Taxonomy

Ischnopelta Stål, 1868

Discocephala (*Ischnopelta*) Stål, 1868: 18; Stål, 1872: 6; Lethierry & Severin, 1893: 83.

Ischnopelta: Berg, 1891: 238; Kirkaldy, 1909: 215; Rolston, 1990: 15, 19–20; Grazia *et al.*, 2015: 712.

Type species: *Discocephala scutellata* Signoret, 1851 (Figs. 9–10), posteriorly designated by Kirkaldy (1909).

Description. Body elliptical elongated, dorsoventrally flattened; dorsal surface slightly convex with dense brown to ferruginous punctures randomly distributed; punctures may form short and irregular lines; ventral surface flattened, with brown to ferruginous punctures. Male body length between 0.8 and 0.9 times the female length.

Head semicircular, wider than long. Mandibular plates wide and flat, surpassing, and overlapping the clypeus anteriorly; apex usually emarginated; lateral margins with convex and reduced anteoocular processes. Posterior margin slightly bending backwards on laterals; dorsal surface with small, unpunctured semicircular areas between ocelli and eyes. Ventral surface of mandibular plates with minute brown to black punctures; setae on the apical half of the lateral margins; 1 + 1 unpunctured areas lateral to the insertion of labrum. Eyes reddish brown, iridescent, and forming sharply rounded angles on mesial margin. Ocelli reddish, framed by a narrow dark brown band; placed over or slightly posterior to the internal angles of the eyes; distance between ocelli 0.32–0.37 times the distance between eyes. Maxillary plates and ocular peduncles horn shaped. Bucculae posteriorly divergent. Labium reaching or slightly surpassing the metacoxae; bearing sparse setae; first segment more robust, insertion distal to the half of bucculae and apex surpassing the anterior margin of prosternum; distal 1/3 of segment IV black; labial groove reddish to dark brown; ratio between segments: I<II>III>IV. Antennae five-segmented; segment I subcylindrical, moderately swollen and covered dorsally by the mandibular plates; segments II and III dorsally flat and with a shallow longitudinal groove, more apparent on II (Fig. 2A–C, gr); segment IV slightly flattened; V subcylindrical; setae scarce on segments I and II and proximal half of III, denser on the distal half of segment II, and on segments IV and V.

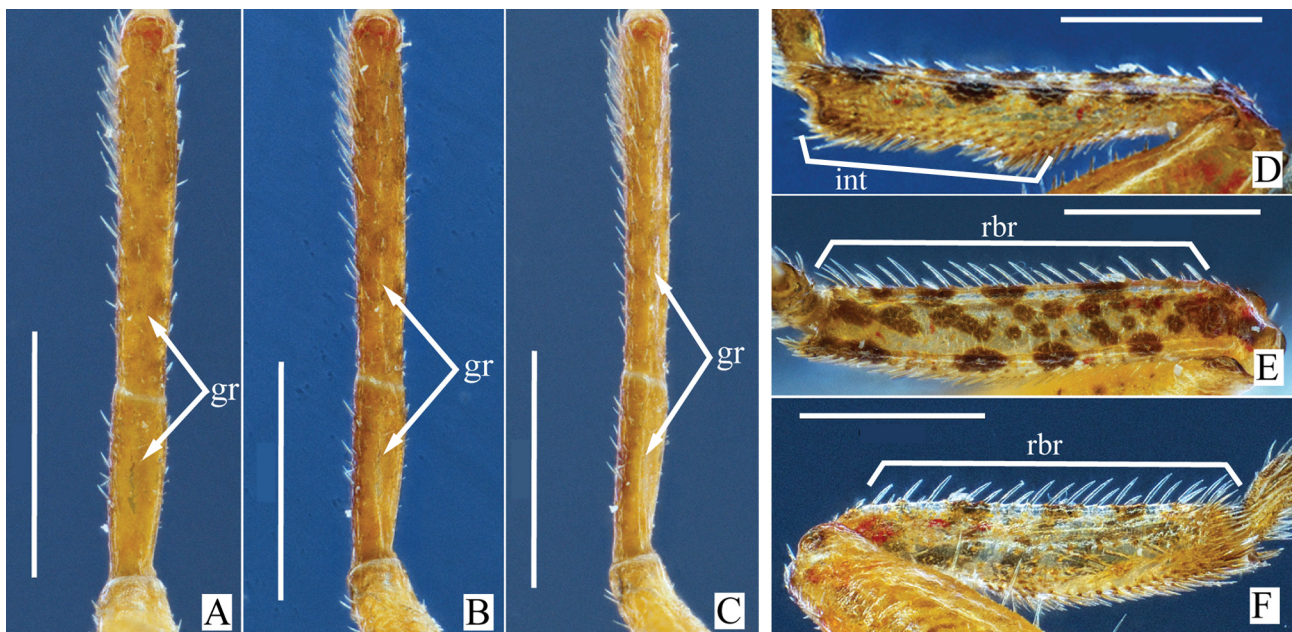

FIGURE 2. *Ischnopelta scutellata* (Signoret, 1851). A–C, antennal segments II and III, dorsal and laterodorsal views (30° and 45°), respectively; D–F, protibiae, lateral, dorsal and ventroposterior views, respectively. Abbreviations: gr, longitudinal groove; int, intumescence; rbr, row of bristles. Scale bars = 0.5 mm.

Thorax. Pronotum subrectangular, slightly bent anteriorly; width across the humeral angles 2.2 to 2.4 times the length, and 1.1 to 1.2 times the width across the anterolateral angles. Anterior margin sinuous; anterolateral margins subrectilinear to slightly convex. Anterolateral angles of pronotum with a small projection or unarmed; humeral angles rounded and slightly swollen. Posterior margin sinuous, weakly concave over the scutellum and convex over the hemelytra. Dorsal surface predominantly convex, with a shallow transversal depression behind the cicatrices; cicatrices with irregularly distributed internal punctures. Scutellum slightly convex dorsally, almost

reaching the end of the body; length 1.6 to 2 times the basal width; postfrenal lobe 1.3 to 1.7 times longer than frenal lobe; basal width 1.4 to 1.6 times the width at frenal constriction; lateral margins of the frenal lobe slightly convex; lateral margins of the post-frenal lobe subrectilinear to slightly convex; apex narrow to broadly rounded. Hemelytra: corium ranging from slightly shorter to longer than the scutellum, reaching at least the anterior margin of connexivum VII; apical angles of urosternites sharply rounded. Prosternum slightly concave. Mesosternum swollen and medially grooved. Metasternum grooved, hexagonal, posteriorly narrowed.

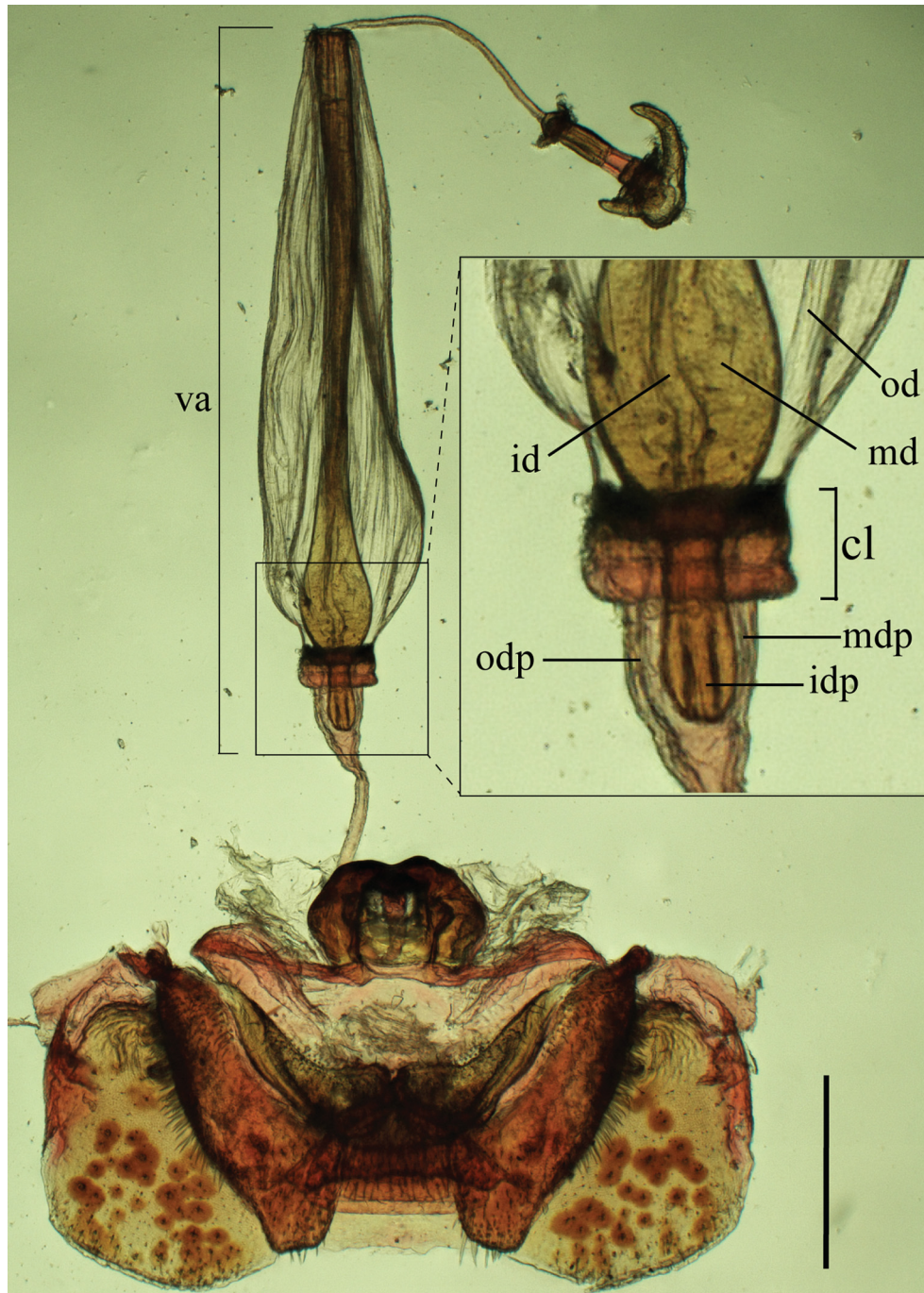

FIGURE 3. *Ischnopelta pellucidula* Rosso & Campos, sp. n. Female genitalia highlighting the proximal portion of the spermathecal vesicular area. Abbreviations: cl, collar; id, internal duct, idp, proximal internal duct; md, median duct; mdp, proximal median duct; od, external duct; odp, proximal external duct; va, vesicular area. Scale bar = 0.5 mm.

Evaporatorium subtriangular, velvet-like and punctured. Ostiole elliptical, ventrolaterally directed. Peritreme spout-like, grooved, slightly bent and not reaching the lateral margin of the evaporatorium. Metathoracic spiracle slightly longer than peritreme. Legs with clavate femora, slightly flattened laterally and with sparse setae; tibiae flattened dorsally, with a wide and shallow longitudinal groove and without setae; ventral surface with many setae; ventral surface of the protibiae swollen on the distal 2/3 (Fig. 2D, int) and with setae on the posterodorsal margin (Fig. 2E–F, rbr). Tarsomeres I about twice the length of the II and slightly shorter than the III; tarsomeres I subcylindrical, II and III slightly flattened laterally; apical 1/3 of tarsal claws black.

Abdomen. Dorsal surface convex. Connexivum densely punctured; lateral margins of each connexival segment with 1+1 brown to dark-brown blotches separated by unpunctured areas; blotches continuous ventrally, the anterior blotch located at the anterior half of the urosternite, the posterior one next to the posterolateral angle. Urosternites slightly convex with 1+1 depressions next to the anterior margin of segments IV to VII, shallower on the last one. Elliptical spiracles outlined by a narrow bright dark-brown band. Small subcircular area between spiracles and trichobothria and part of the pseudosutures in urosternites III to VII, with a superficial aspect of minute iridescent comb (gross mode, they are visualized as an elongated light-brown blotch). Mesial trichobothria placed on the line tangent to the lateral limit of spiracles.

Male. Urosternites IV to VI progressively shorter on midline; urosternite VII on midline 1.3 times longer than IV to VI taken together (e.g., Fig. 9B). Anterior margin of urosternite VII widely V-shaped, almost attaining a line connecting the posterior angles of urosternite IV. **Genitalia.** Pygophore dorsoventrally flat (e.g., Fig. 11E). Posterolateral angles not projected in some species (e.g., Fig. 4B, C); when projected the posterolateral angles are laterally compressed (e.g., Fig. 4A), lateral surface convex, mesial surface concave, rounded at apex. Segment X flattened dorsoventrally, as wide as or wider than half the width of the pygophore (e.g., Figs. 9C; 11C), and

exceeding posteriorly the ventral rim by at least half the length of the segment X (e.g., Figs. 9D; 11D). Parameres inserted ventrally to segment X. Cup-like sclerite well developed, located between the parameres and usually visible ventrally posterior to the ventral rim (Fig. 11D, cls). Phallus: phallosome elongated, slightly tapering towards vesica; the later broader at least at the basal 1/3, apical half or more sinuous and accompanying the ductus seminis distalis; conjunctiva absent (e.g., Fig. 9J).

Female. Median portion of the posterior margin of urosternite VI concave (e.g., Fig. 10B). **Genitalia.** Valvifers VIII dorsoventrally flattened, usually covering the valvifers IX and at least the base of laterotergites IX (Fig. 5). Spiracles in laterotergites VIII covered by the valvifers VIII. Valvifers IX oblique posteriorly emarginated, rounded and setose at apex; suture line clearly visible (e.g., Fig. 10D). Laterotergites IX triangular, rounded to angular and setose at apex; free portion dorsoventrally flattened; covered portion swollen. Ring sclerites absent. Thickening of vaginal intima large, half the width of valvulae IX, discoid, and flattened dorsoventrally (e.g., Fig. 10D). Ductus receptaculi: outer duct of vesicular area folded over itself on the proximal portion, forming a collar (Fig. 3, cl) and delimiting a narrow funnel. Median duct constricted within the collar, and usually dilated distal to the collar; inner duct uniformly cylindrical throughout its extension. Pars intermedialis narrower than capsula seminalis. Capsula seminalis globose, with one or two lateral projections.

Distribution. Venezuela, Brazil, Bolivia, Paraguay, Argentina (Figs. 6; 7; 8).

Comments. The characteristics proposed by Rolston (1990) for the identification of *Ischnopelta* in his key and diagnoses for the genera of broadheaded discocephalines are still valid. Besides the characteristics listed by Rolston (1990), the long scutellum with the frenal lobe in average 0.65 times smaller than the post-frenal in *Ischnopelta*, differs from the subtriangular scutellum with subequal frenal and post-frenal lobes in *Discocephala* (Becker & Grazia 1992), as well as in *Nigrisagitta* Rosso & Campos, 2017 (Rosso & Campos 2017a, b). It is noteworthy that, within the broadheaded Discocephalini, the dilated distal

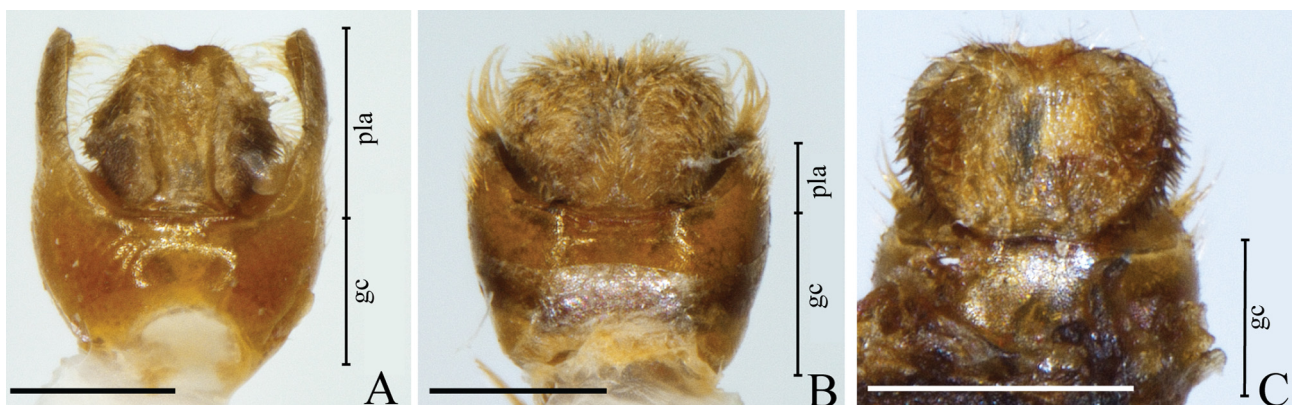

FIGURE 4. Pygophore. A, *Ischnopelta bechyneorum* Rosso & Campos, sp. n.; B, *Ischnopelta vellozia* Rosso & Campos, sp. n.; C, *Ischnopelta anangulata* Rosso & Campos, sp. n. Abbreviations: gc, genital capsule; pla, posterolateral angles. Scale bar = 0.5 mm.

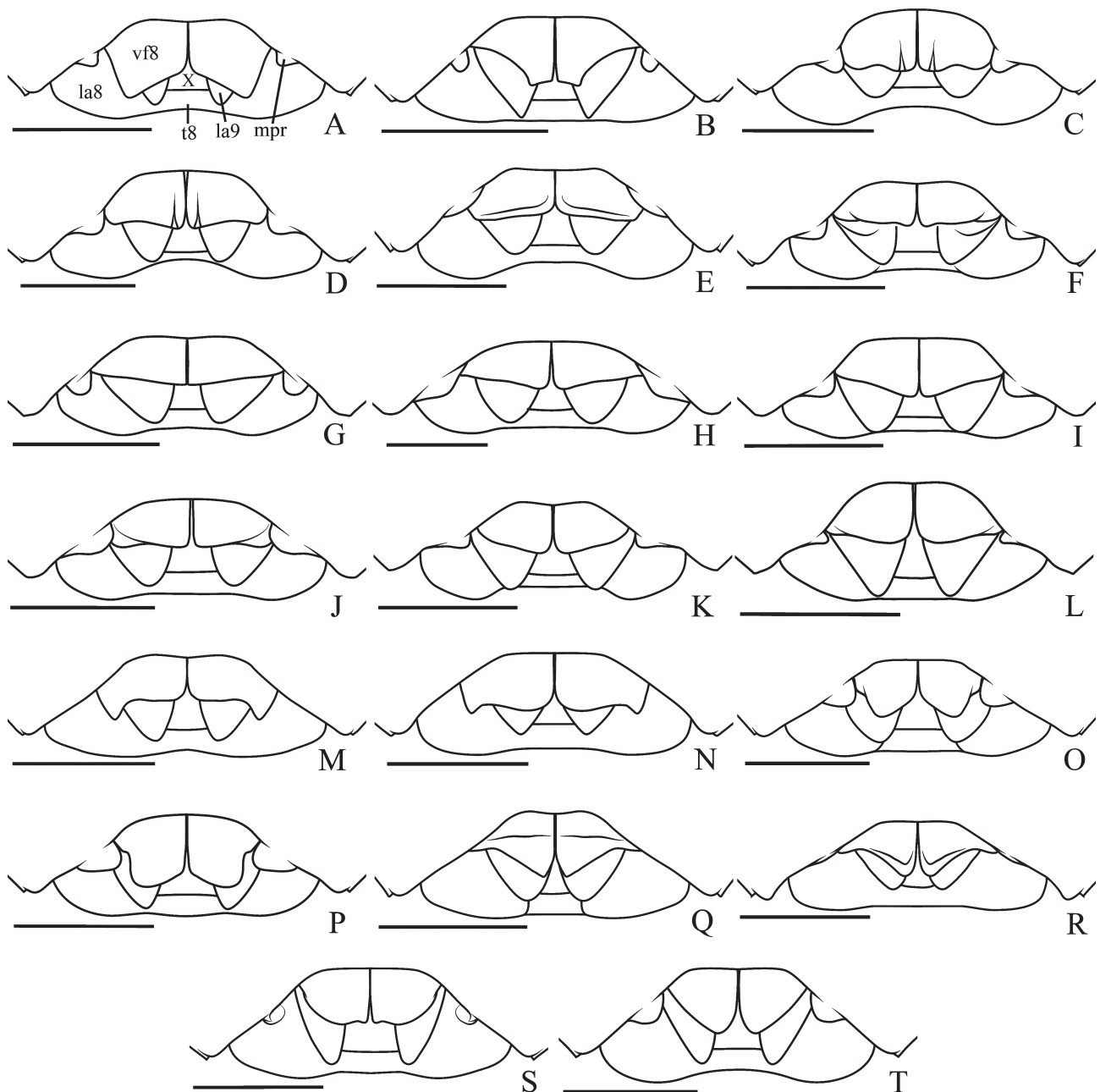

FIGURE 5. Female genital plates. A, *Ischnopelta scutellata* (Signoret, 1851); B, *Ischnopelta bechyneorum* Rosso & Campos, sp. n.; C, *Ischnopelta confusa* Rosso & Campos, sp. n.; D, *Ischnopelta magna* Rosso & Campos, sp. n.; E, *Ischnopelta cylindrata* Rosso & Campos, sp. n.; F, *Ischnopelta impunctata* Rosso & Campos, sp. n.; G, *Ischnopelta luteicornis* (Walker, 1867); H, *Ischnopelta cristulata* Rosso & Campos, sp. n.; I, *Ischnopelta coralinae* Rosso & Campos, sp. n.; J, *Ischnopelta ruckesi* Rosso & Campos, sp. n.; K, *Ischnopelta pellucidula* Rosso & Campos, sp. n.; L, *Ischnopelta parvula* Rosso & Campos, sp. n.; M, *Ischnopelta vellozia* Rosso & Campos, sp. n.; N, *Ischnopelta wigodzinskyi* Rosso & Campos, sp. n.; O, *Ischnopelta alalonga* Rosso & Campos, sp. n.; P, *Ischnopelta crassula* Rosso & Campos, sp. n.; Q, *Ischnopelta cordiformis* Rosso & Campos, sp. n.; R, *Ischnopelta montana* Rosso & Campos, sp. n.; S, *Ischnopelta guarani* Rosso & Campos, sp. n.; T, *Ischnopelta marginella* Rosso & Campos, sp. n.. Abbreviations: vf8, valvifers VIII; la8, laterotergites VIII; la9, laterotergites IX; mpr, projection on the lateral third of posterior margin of sternite VII; t8, mediotergite VIII; X, segment X. Scale bars = 1 mm.

2/3 of protibia, the longitudinal groove on antennal segments II and III, and the collar on the proximal portion of the vesicular area in the spermatheca, were only observed in *Ischnopelta*. Regarding the differentiation between species of *Ischnopelta*, only the genital characteristics allow an unambiguous identification.

Key to the males of *Ischnopelta* Stål, 1868

1. Pygophore posterolateral angles perpendicular to the frontal plane, slightly bent ventrally, curved; apex of parameres bent lateroposteriorly; segment X longer than wide, oval, and emarginated (Fig. 9C–M).....

-*I. scutellata* (Signoret, 1851)
- Pygophore posterolateral angles oblique to the frontal plane at apex, convergent from the base; apex of parameres bent laterally; segment X usually as wide as long, rounded (Figs. 18C–M; 24C–M; 29C–M; 31C–M; 39C–E; 43A–K; 44C–M) 2
- Other combinations for the characteristics of the pygophore posterolateral angles, and for the shape of the parameres and segment X (Fig. 4A–C)..... 8
2. Membrane of hemelytra with apical margin subrectilinear (Figs. 29A–B; 39A–B) 3
- Membrane of hemelytra with apical margin convex 4
3. Wide blotches on lateral of urosternites; denticles on posterolateral angles of urosternite VII present (Fig. 29B, dt)..... *I. impunctata* Rosso & Campos, sp. n.
- Minute blotches on lateral of urosternites; denticles on posterolateral angles of urosternite VII absent (Fig. 39A–B)..... *I. parvula* Rosso & Campos, sp. n.
4. Length of mandibular plates anterior to the clypeus shorter than 1/3 of total length of the head; ventral surface of the parameres with a longitudinal sinuous crest (Figs. 41A–D; 43B and E, vcp) *I. pellucidula* Rosso & Campos, sp. n.
- Length of mandibular plates anterior to the clypeus equal to or larger than 1/3 of total length of the head; ventral surface of the parameres with a transversal or oblique crest 5
5. Ventral surface of parameres with a transversal crest (Fig. 24G, vcp) *I. cristulata* Rosso & Campos, sp. n.
- Ventral surface of parameres with an oblique crest (Fig. 31G, vcp) 6
6. Median portion of urosternite VII reaching anteriorly the imaginary transversal line connecting the spiracles of urosternite V (Fig. 31B)..... *I. luteicornis* (Walker, 1867)
- Median portion of urosternite VII not reaching anteriorly the imaginary transversal line connecting the spiracles of urosternite V 7
7. Lateral margin of the head of parameres convex; apical margin of parameres convex (Fig. 18D, F–H, amp)..... *I. coralinae* Rosso & Campos, sp. n.
- Lateral margin of the head of parameres subrectilinear at distal portion; apical margin of parameres subrectilinear (Fig. 44F–G, amp)..... *I. ruckesi* Rosso & Campos, sp. n.
8. Pygophore with posterolateral angles not developed (Figs. 4C; 13A–D) *I. anangulata* Rosso & Campos, sp. n.
- Pygophore with posterolateral angles developed 9
9. Posterolateral angles longer than the rest of the pygophore (Fig. 4A) 10
- Posterolateral angles shorter than the rest of the pygophore (Fig. 4B) 15
10. Apex of scutellum broadly rounded, usually emarginated; median region of ventral abdomen not punctured; posterolateral angles of urosternite VII without denticles; head of parameres subparallel to the frontal plane; secondary gonopore circular (Figs. 34A–B; 34F–M)..... *I. marginella* Rosso & Campos, sp. n.
- Apex of scutellum narrowly rounded; median region of ventral abdomen slight or moderately punctured; denticles on posterolateral angles of sternite VII present; head of parameres perpendicular or oblique to the frontal plane; secondary gonopore beveled (Figs. 11J; 14J; 16J; 20J) 11
11. Bucculae slightly higher than the first segment of the labium; setae on the posterodorsal margin of protibiae as long as in the remaining surface; median portion of urosternite VII not reaching anteriorly the imaginary line connecting the spiracles of urosternite V; posterolateral angles of pygophore convergent from the base; head of parameres perpendicular to the frontal plane 12
- Bucculae low, not concealing the first segment of the labium; setae on the posterodorsal margin of protibiae longer than the remaining surface; median portion of urosternite VII reaching anteriorly the imaginary line connecting the spiracles of urosternite V; posterolateral angles of pygophore subparallel; head of parameres oblique to the frontal plane..... 13
12. Corium slightly shorter than scutellum; posterolateral angles of pygophore about 1.6 times longer than the rest of the pygophore, oblique to the frontal plane at apex; dorsal rim of pygophore sinuous (Fig. 11A, C–E)..... *I. alalonga* Rosso & Campos, sp. n.
- Corium as long as scutellum; posterolateral angles of pygophore about 1.8 times longer than the rest of the pygophore, perpendicular to the frontal plane at apex; dorsal rim of pygophore concave (Fig. 22A, C–E) *I. crassula* Rosso & Campos, sp. n.
13. Ocelli slightly posterior to the transversal line connecting the inner angles of the eyes; labrum inserted slightly posterior to half of the distance between the anterior margin of the eyes and the apex of the mandibular plates; lateral margins of urosternites with wide blotches (Fig. 27A–B).. *I. guarani* Rosso & Campos, sp. n.
- Ocelli on the same line of the inner angles of the eyes; labrum inserted anterior to half of the distance between the anterior margin of the eyes and the apex of the mandibular plates; lateral margins of urosternites with narrow blotches 14
14. Corium as long as scutellum; segment X as long as wide; head of parameres flat, narrow at apex (Fig. 14A, F–I, L–M) *I. bechyneorum* Rosso & Campos, sp. n.
- Corium shorter than scutellum; segment X longer than wide; head of parameres slightly swollen (Fig. 38A, C, F–I) *I. paigagua* Rosso & Campos, sp. n.
15. Ocelli posterior to the imaginary line connecting the inner angles of the eyes; apex of scutellum widely rounded; corium slightly shorter than scutellum; apical margin of membrane of hemelytra subrectilinear; lateral margins of urosternites with wide blotches; ventral rim of pygophore with 1+1 subtriangular lateral projections (Fig. 16A–B, C–E)..... *I. confusa* Rosso & Campos, sp. n.
- Ocelli on the imaginary line connecting the inner angles of the eyes; apex of scutellum narrowly rounded; corium as long as scutellum; lateral margins of urosternites with narrow blotches; apical margin of membrane of hemelytra convex; ventral rim of pygophore without projections 16
16. Bucculae as high as the first labial segment; labrum inserted posterior to the half of the distance between the anterior margin of the eyes and the apex of the mandibular plates; pro- and mesosternum punctured; posterolateral angles of pygophore slightly shorter than the rest of the pygophore; segment X as wide as long, rounded, strongly sclerotized

- (Fig. 36B, C–D, L–M)..... *I. montana* Rosso & Campos, sp. n.
- Bucculae low, not concealing the first labial segment; labrum inserted anterior to the half of the distance between the anterior margin of the eyes and the apex of the mandibular plates; pro- and mesosternum unpunctured, posterolateral angles of pygophore shorter than half the rest of the pygophore; segment X wider than long, cordiform, membranous mesially..... 17
17. Setae on posterodorsal margin of protibiae as long as the others on the remainder surface; width of the head of parameres more than twice the maximum width of the basal portion; parameres without apical projections or processes, only a small rounded top (Fig. 46F–I)..... *I. vellozia* Rosso & Campos, sp. n.
- Setae on posterodorsal margin of protibiae longer than the others (Fig. 2E, F, rbr); width of the head of parameres less than twice the maximum width of the basal portion; parameres with conspicuous apical process 18
18. Median region of abdomen unpunctured; median portion of urosternite VII reaching anteriorly the imaginary line connecting the spiracles of urosternite V; dorsal rim of pygophore convex, posterolateral angles about 0.5 times the length of the rest of the pygophore; inner and outer margins of the head of parameres convex, apical process wide at apex (Fig. 20B–I)..... *I. cordiformis* Rosso & Campos, sp. n.
- Median region of abdomen moderately punctured; median portion of urosternite VII not reaching anteriorly the line connecting the spiracles of urosternite V; dorsal rim of pygophore sinuous, posterodorsal angles about 0.3 times the length of the rest of the pygophore; head of parameres with inner margin sinuous, outer margin strongly convex, minute apical process acute at apex (Fig. 48B–I)..... *I. wigodzinskyi* Rosso & Campos, sp. n.
4. Valvifers VIII as long as wide, lateral portion of the posterior margin subrectilinear, subequal in length to the median portion of the posterior margin (Figs. 5A; 10B).... *I. scutellata* (Signoret, 1851)
- Valvifers VIII wider than long, lateral portion of the posterior margin concave, median portion narrow, subrectilinear and about 0.3 times the length of the lateral portion (Figs. 5B; 15C, vf8)..... *I. bechyneorum* Rosso & Campos, sp. n.
5. Valvifers VIII with a longitudinal groove delimiting a fold at the distal half of the sutural margin (Fig. 5C, D)..... 6
- Valvifers VIII variable, never with a groove nor a fold at the distal half of the sutural margin 7
6. Average length shorter than 10 mm, bucculae as high as the first labial segment; coria slightly shorter than scutellum; mesosternum unpunctured; foldings on the lateral 1/3 of the posterior margin of urosternite VII laminate (Figs. 5C; 17A–C, mpr)..... *I. confusa* Rosso & Campos, sp. n.
- Length greater than 10 mm, bucculae low, not concealing the first labial segment; coria as long as scutellum; mesosternum punctured; foldings on the lateral 1/3 of posterior margin of urosternite VII thick (Figs. 5D; 33A–C, mpr) *I. magna* Rosso & Campos, sp. n.
7. Posterior margins of valvifers VIII sinuous, posteriorly projected lateral to the laterotergites IX (Fig. 5M, N)..... 8
- Posterior margins of valvifers VIII variable, never projected lateral to the laterotergites IX 9
8. Posterior projection of valvifers VIII about half of the length of the sutural margin; setae on posterodorsal margin of protibiae as long as the others; foldings on the lateral 1/3 of the posterior margin of urosternite VII hidden beneath the sternite (Figs. 5M; 47C, vf8, mpr)..... *I. vellozia* Rosso & Campos, sp. n.
- Posterior projection of valvifers VIII not greater than 1/3 the length of sutural margin; setae on posterodorsal margin of protibiae longer than the others; foldings on the lateral 1/3 of posterior margin of urosternite VII absent (Figs. 5N, 49C, vf8)..... *I. wigodzinskyi* Rosso & Campos, sp. n.
9. Valvifers VIII projected posteriorly over the limits between the laterotergites IX and segment X by more than half the length of laterotergites IX (Fig. 5Q, R, T)..... 10
- Valvifers VIII variable, never projected over the limits between the laterotergites IX and segment X..... 12
10. Posterior margin of valvifers VIII subrectilinear; foldings on the lateral 1/3 of posterior margin of sternite VII well projected over the laterotergites VIII (Fig. 5T) *I. marginella* Rosso & Campos, sp. n.
- Posterior margin of valvifers VIII sinuous, foldings on the lateral 1/3 of posterior margin of urosternite VII absent or obsolete (Fig. 5Q, R) 11
11. Bucculae slightly higher than the first labial segment; labrum inserted anteriorly to half the distance between the anterior margin of the eyes and the apex of mandibular plates; pro- and mesosternum unpunctured; setae on the posterodorsal margin of protibiae larger than the others; foldings on the lateral 1/3 of the posterior margin of urosternite VII absent (Fig. 21B) *I. cordiformis* Rosso & Campos, sp. n.
- Bucculae low, not concealing the first labial segment; labrum inserted posterior to half the distance between the anterior margin of the eyes and the apex of mandibular plates; pro- and mesosternum punctured; setae on the posterodorsal

Key to the females of *Ischnopelta* Stål, 1868

1. Posteriormost portion of valvifers VIII in a round projection over the middle of laterotergites IX (Fig. 5O, P), or forming a 90° angle over laterotergites VIII (Fig. 5A) or over laterotergites IX (Fig. 5B) 2
- Posteriormost portion of valvifers VIII variable, never as above..... 5
2. Posteriormost portion of valvifers VIII in a round projection over the middle of laterotergites IX (Fig. 5O, P)..... 3
- Posteriormost portion of valvifers VIII forming a 90° angle over laterotergites VIII (Fig. 5A) or over laterotergites IX (Fig. 5B) 4
3. Coria as long as scutellum, well surpassing the apical angles of urosternite VI; membrane of hemelytra surpassing the posterior margin of the genital plates; median portion of the posterior margin of sternite VII subrectilinear (Figs. 5O; 12A–B) *I. alalonga* Rosso & Campos, sp. n.
- Coria slightly shorter than scutellum, not attaining the apical angles of urosternite VI; membrane of hemelytra not reaching the posterior margin of the genital plates; median portion of the posterior margin of urosternite VII slightly concave (Figs. 5P; 23A–B)..... *I. crassula* Rosso & Campos, sp. n.

- margin of protibiae as long as the others; foldings on the lateral 1/3 of posterior margin of sternite VII present (Fig. 37C, mpr)..... *I. montana* Rosso & Campos, sp. n.
12. Posterior margin of valvifers VIII broadly convex, with small sinuities at the lateral and medial limits; scutellum narrowly rounded at apex (Figs. 5S; 28A–B).....
.....*I. guarani* Rosso & Campos, sp. n.
- Posterior margin of valvifers VIII subrectilinear or slightly sinuous, never broadly convex (Fig. 5E–L) 13
13. Posterior margin of valvifers VIII with the lateral part oblique to the longitudinal axis; bucculae slightly higher than the first labial segment; labrum inserted posterior to half the distance between the anterior margin of the eyes and the apex of mandibular plates; pro- and mesosternum punctured; setae on the posterodorsal margin of protibiae longer than the others; median duct of the vesicular area cylindrical proximal to the collar (Figs. 5E; 26B, D, mdp)
.....*I. cylindrata* Rosso & Campos, sp. n.
- Posterior margin of valvifers VIII without a clearly defined lateral part; bucculae low, not concealing the first labial segment; labrum inserted anterior to half the distance between the anterior margin of the eyes and the apex of mandibular plates; pro- and mesosternum unpunctured; setae on the posterodorsal margin of protibiae as long as the others; median duct of vesicular area dilated proximal to the collar 14
14. Lateral blotches on urosternites wide; membrane of hemelytra surpassing the posterior margin of mediotergite VIII; median portion of urosternite VII with few punctures; denticles on posterolateral angles of urosternite VII present (Fig. 30A–B).....*I. impunctata* Rosso & Campos, sp. n.
- Lateral blotches on urosternites narrow; membrane of hemelytra not reaching the posterior margin of mediotergite VIII; median portion of urosternite VII moderately to densely punctured; denticles on posterolateral angles of urosternite VII absent 15
15. Foldings on the lateral 1/3 of the posterior margin of urosternite VII thick (Fig. 32C, mpr)
.....*I. luteicornis* (Walker, 1867)
- Foldings on the lateral 1/3 of the posterior margin of urosternite VII laminate..... 16
16. Length of the mandibular plates anterior to the clypeus equal to or longer than the length between the base of the head and the apex of clypeus; evaporatorium reaching the lateral margin of mesopleura; lateral margin of laterotergites IX subrectilinear 17
- Length of the mandibular plates anterior to the clypeus shorter than the length between the base of the head and the apex of clypeus; evaporatorium not reaching the lateral margin of mesopleura; lateral margin of laterotergites IX convex..... 19
17. Posterior margin of valvifers VIII subrectilinear, laterotergites IX not attaining the posterior margin of mediotergite VIII (Figs. 5H; 25C); inner duct of vesicular area convoluted within the dilation of the median duct distal to the collar (Fig. 25D)
.....*I. cristulata* Rosso & Campos, sp. n.
- Posterior margin of valvifers VIII sinuous (Figs. 5J, 45C), if the margin is subrectilinear the laterotergites IX attain the posterior margin of mediotergite VIII (Figs. 5I, 19C); inner duct of vesicular area rectilinear..... 18
18. Median portion of the posterior margin of urosternite VII subrectilinear; laterotergites IX reaching the posterior margin of mediotergite VIII; lateral margin of valvifers IX subrectilinear; median duct of vesicular area not widened distally (Fig. 19B, D, vF9, md)
.....*I. coralinae* Rosso & Campos, sp. n.
- Median portion of the posterior margin of urosternite VII concave; laterotergites IX not reaching the posterior margin of mediotergite VIII; lateral margin of valvifers IX convex; median duct of vesicular area subtly widened distally (Fig. 45B, D, vF9, md).....*I. ruckesi* Rosso & Campos, sp. n.
19. Lateral blotches of urosternites long and narrow; laterotergites IX reaching the posterior margin of mediotergite VIII (Fig. 42B and D).....
.....*I. pellucidula* Rosso & Campos, sp. n.
- Lateral blotches of urosternites minute; laterotergites IX almost reaching the posterior margin of mediotergite VIII (Fig. 40B–C).....*I. parvula* Rosso & Campos, sp. n.

***Ischnopelta scutellata* (Signoret, 1851)** (Figs. 2; 5A; 9–10)

Discocephala scutellata Signoret, 1851: 334.

Discocephala (Ischnopelta) scutellata: Stål, 1868: 18; Stål, 1872: 6; Lethierry & Severin, 1893: 84.

Ischnopelta scutellata: Berg, 1891: 238; Kirkaldy, 1909: 215; Rolston, 1990: 20; Grazia *et al.*, 2015: 712.

Holotype. VENEZUELA. Muséum National d’Histoire Naturelle (MNHN), Paris, France (examined).

Material examined. 20 males and 28 females. BRAZIL, *Mato Grosso*, Santa Teresinha (close to the outfall of Tapirapé river), 1 male, 14.I.1963, Borys Malkin, [-10.616111, -50.613056], (CAS); Campo Novo do Parecis, Utiariti (Papagaio river), 4 males and 7 females, 22-31.X.1966, Lenko & Pereira (K. Lenko Col.), [-13.0215, -58.2870], (UFRG); Chapada dos Guimarães, 1 female, homotype (det. H. Ruckes, 1961), [-15.433333, -55.75], (AMNH, Acc:23739); 3 males and 3 females, 01.II.1961, J. & B. Bechyné, [-15.433333, -55.75], (MPEG); 1 male, March, [-15.433333, -55.75], (USNM); Cuiabá, 3 males and 1 female, 14.II.1961, J. & B. Bechyné, [-15.5960, -56.0970], (MPEG); *Tocantins*, Palmas (Fazenda Céu, Serra do Lageado), 1 female, XI.1992, Exp. MCN/MZSP, [-10.1669, -48.3328], 6-96 (MCNZ); *Distrito Federal*, Brasília, Planaltina (32 km N Brasília), 1 male and 2 females, 17–21.XI.1997, T.J. Henry, [-15.4548, -47.6130], (USNM); *Goiás*, Corumbá de Goiás (Fazenda Monjolinho), 1 female, 14.VI.1942, F. Lane, [-15.9275, -48.8103], (UFRG); *Minas Gerais*, Cardeal Mota (4 km SW Cardeal Mota and Rio Cipó, Rod. MG 10), 2 males and 2 females, 6.XI.1997, T.J. Henry & A. Paula, [-19.3564, -43.655], (USNM); Paracatu, 1 female, VI.1960, Exp. Formosa, [-17.2211, -46.8741], (MNRJ); Pirapora, 1 female, XI.1975, M. Alvarenga, [-17.3374, -44.9271], (AMNH); *Goiás*, Jataí, (Fazenda Cachoeirinha), 2 males and 3 females, X.1962, Exp. Dep. Zool., [-17.8872, -51.7182], (UFRG); (Fazenda



FIGURE 6. Distribution of *Ischnopelta alalonga* Rosso & Campos, sp. n.; *Ischnopelta anangulata* Rosso & Campos, sp. n.; *Ischnopelta bechyneorum* Rosso & Campos, sp. n.; *Ischnopelta cylindrata* Rosso & Campos, sp. n.; *Ischnopelta confusa* Rosso & Campos, sp. n.; *Ischnopelta coralinae* Rosso & Campos, sp. n.; *Ischnopelta scutellata* (Signoret, 1851).

Nova Orlandia), 2 males and 2 females, 1964, Martins, Morgante & Silva, [-17.8872, -51.7182], (UFRG); São Paulo, Pereira Barreto (old village from Lussanvira, Zone of the old Estrada de Ferro Noroeste Brazil—N.O.B.), 1 male and 1 female, 4.X.1938, Instituto Oswaldo Cruz, [-20.651389, -51.072222], (FIOC); Ribeirão Preto, 1 female, 11.XII.1995, A.M. de Faria, [-21.1794, -47.7999], (UNIFESP), 1 female, III.1996, A.M. de Faria, [-21.1794, -47.7999], (UNIFESP).

Description. Male and female respectively 1.8 and 1.9 times longer than wide; dorsal surface somewhat glossy and dark yellowish; ventral surface pale yellow.

Head two times wider than long; anterior margin slightly emarginated. Clypeus 0.4 times the length of head. Distance between ocelli 0.3 times the distance between the eyes, on the line connecting the inner angles of the eyes. Maxillary plates and ventral ocular peduncles pale-yellow; punctures on bucculae scarce, denser on ocular peduncles. Bucculae low, not concealing the first labial segment. Labium slightly surpassing the metacoxae. Labrum inserted halfway between the anterior margin of the eyes and the apex of mandibular plates. Antennae light brown, with irregular reddish striated blotches on segments II and III; segments ratio: I=II<III<IV<V.



FIGURE 7. Distribution of *Ischnopelta cordiformis* Rosso & Campos, sp. n.; *Ischnopelta crassula* Rosso & Campos, sp. n.; *Ischnopelta cristulata* Rosso & Campos, sp. n.; *Ischnopelta guarani* Rosso & Campos, sp. n.; *Ischnopelta impunctata* Rosso & Campos, sp. n.; *Ischnopelta luteicornis* (Walker, 1867); *Ischnopelta magna* Rosso & Campos, sp. n..

Thorax. Pronotum as long as the head; width at the anterolateral angles as wide as the head. Scutellum surpassing the apical angles of urosternite VI, 1.8 times longer than wide at base; post-frenal lobe 1.6 times longer than frenal; post-frenal lobe narrowly rounded at apex. Hemelytra: corium slightly shorter than scutellum; in some specimens the radial vein is continued by a reddish line; apical margin of hemelytral membrane convex. Pro-, meso-, and metapleura pale-yellow, moderately punctured. Evaporatorium reaching the lateral margin of mesopleura. Legs dark yellowish, femora with punctures and reddish striated blotches on distal half, tibiae

moderately punctured, setae on posterodorsal margin of protibiae longer than the others.

Abdomen dark yellowish; urosternites weakly punctured on median third, more densely on lateral thirds. Dark spots at the lateral of urosternites narrow, the anterior one longer than the posterior; minute spine present at apical angles of urosternite VII.

Male. Median portion of the posterior margin of urosternite VII subrectilinear; urosternite VII surpassing anteriorly the imaginary line connecting the spiracles of urosternite V. **Genitalia.** Dorsal rim of pygophore subrectilinear (Fig. 9C, dr); ventral rim shallowly



FIGURE 8. Distribution of *Ischnopelta marginella* Rosso & Campos, sp. n.; *Ischnopelta montana* Rosso & Campos, sp. n.; *Ischnopelta paiagua* Rosso & Campos, sp. n.; *Ischnopelta parvula* Rosso & Campos, sp. n.; *Ischnopelta pellucidula* Rosso & Campos, sp. n.; *Ischnopelta ruckesi* Rosso & Campos, sp. n.; *Ischnopelta vellozia* Rosso & Campos, sp. n.; *Ischnopelta wigodzinskyi* Rosso & Campos, sp. n..

concave (Fig. 9D, vr). Posterolateral angles 1.3 times longer than the rest of the pygophore, perpendicular to the frontal plane, slightly bent ventrally, divergent from the base and slightly convergent at apex (Fig. 9C–E, pla). Setae short and sparse on the posterior half of the ventral and lateral surfaces of the pygophore, and on the lateral surface of the posterolateral angles; setae long and dense on the ventral rim, and on the ventral margin of the posterolateral angles. Segment X longer than wide, not reaching the apex of the posterolateral angles and parameres; oval, and deeply emarginated apically; lateral

and apical margins sclerotized and covered by setae; basal margin and mid-longitudinal surface membranous (Figs. 9C and E, X; 9L–M). Parameres falciform, flat, as long as the posterolateral angles; distal portion oblique to the frontal plane; outer margin convex, inner margin sinuous, with strong excavation on the distal half; apex aculeiform, convergent, ventroposterioly directed; setae covering the posterior half of the ventral surface (Fig. 9F–I). Cup-like sclerites little developed. Phallus: vesica broader on proximal half, bearing ventral and lateral expansions, followed by a lateral curvature; distal half

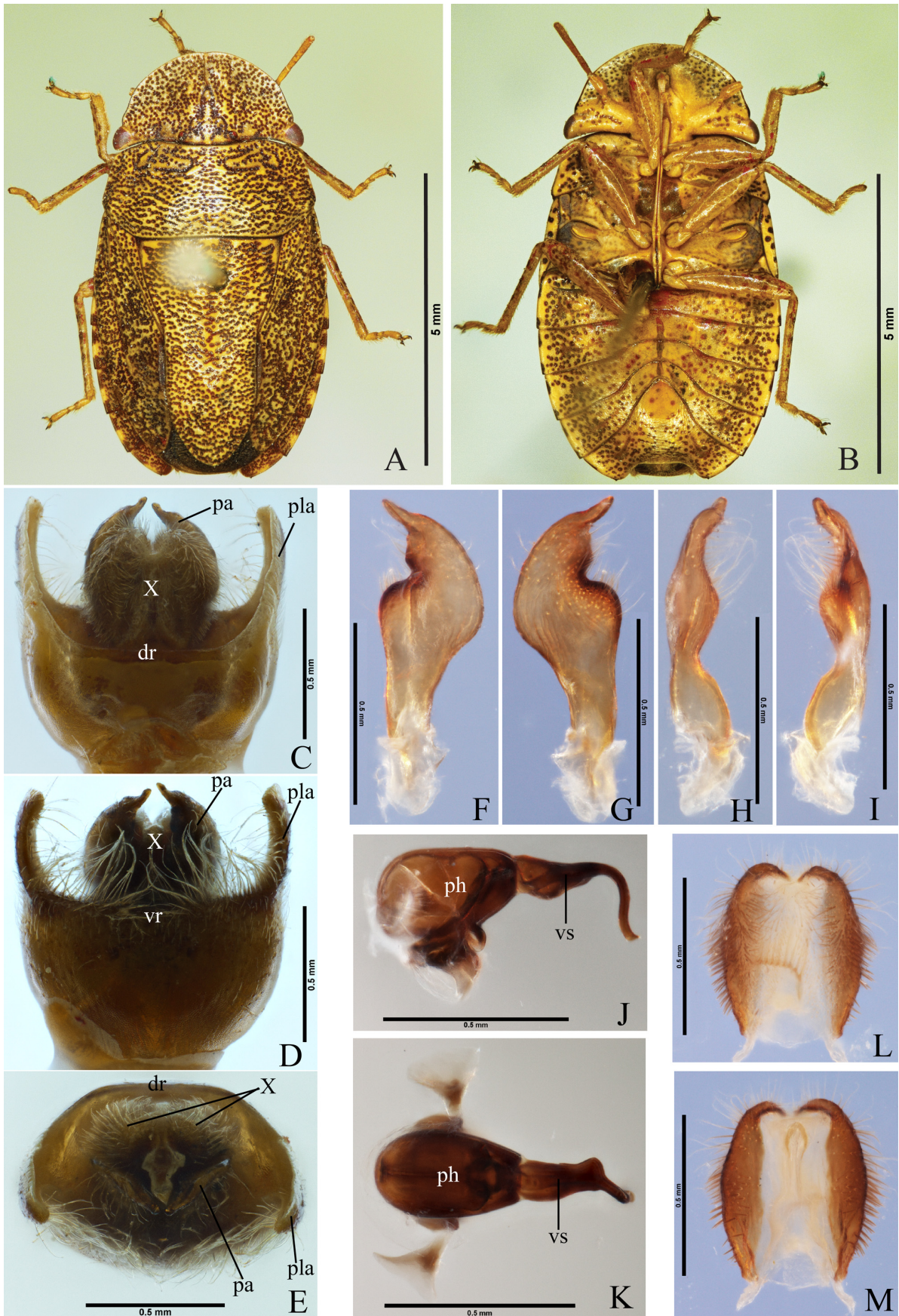

FIGURE 9. *Ischnopelta scutellata* (Signoret, 1851). Male. A, dorsal view; B, ventral view; C–E, pygophore: dorsal, ventral, and posterior views respectively; F–I, parameters: dorsal, ventral, external and internal lateral views, respectively; J–K, phallus: lateral and dorsal views, respectively; L–M, segment X, dorsal and ventral views, respectively. Abbreviations: dr, dorsal rim; pa, parameter; ph, phalloteca; pla, posterolateral angle; vr, ventral rim; vs, vesica; X, segment X.

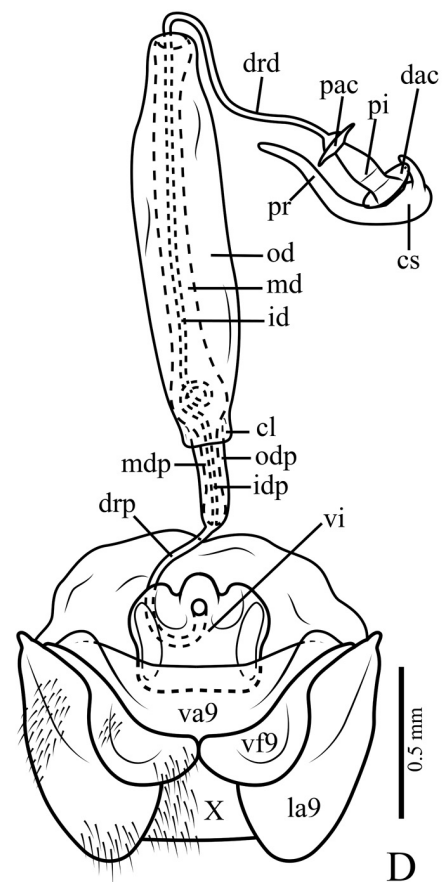
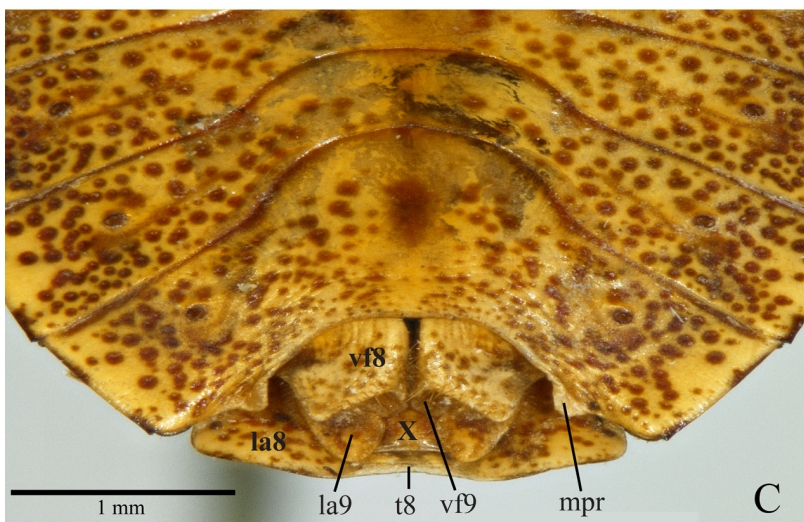
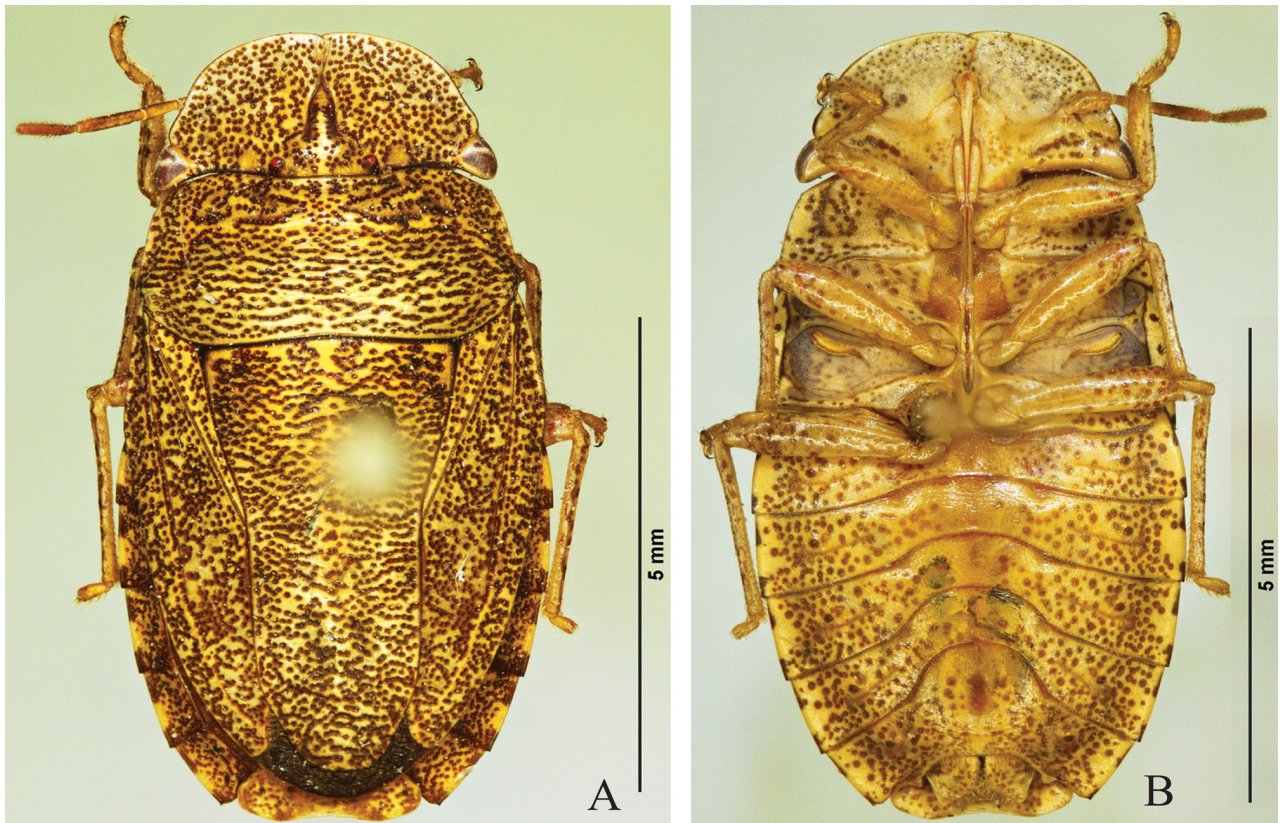

FIGURE 10. *Ischnopelta scutellata* (Signoret, 1851). Female. A, dorsal view; B, ventral view, C, genital plates ventroposterior view (45°); D, internal genitalia. Abbreviations: cl, collar; cs, seminalis capsule; dac, distal annular crest; drd, distal ductus receptaculi; drp, proximal ductus receptaculi; id, internal duct; idp, proximal internal duct; la8, laterotergite VIII; la9, laterotergite IX; md, medium duct; mdp, proximal medium duct; mpr, projection on the lateral third of posterior margin of sternite VII; od, external duct; odp, proximal external duct; pac, proximal annular crest; pi, pars intermedialis; pr, projection; t8, mediotergite VIII; va9, valvulae IX; vf8, valvifer VIII; vf9, valvifer IX; vi, thickening of vaginal intima; X, segment X.

TABLE 1. Measurements (mean, standard deviation, minimum and maximum) and number of *Ischnopelta scutellata* (Signoret, 1851) specimens evaluated (n).

Body structure	Measurements performed	Male		Female	
		n	Measurements (mm)	n	Measurements (mm)
Body	tl	15	7.28±0.22; (6.98–7.72)	26	8.59±0.23; (8.22–8.98)
	mw		4.03±0.14; (3.77–4.21)		4.60±0.17; (4.23–4.94)
Head	hl	19	1.58±0.09; (1.33–1.71)	26	1.73±0.07; (1.57–1.85)
	cl		0.54±0.03; (0.48–0.60)		0.61±0.03; (0.56–0.66)
	hw		3.25±0.11; (3.05–3.43)		3.54±0.07; (3.38–3.68)
	iod		0.89±0.03; (0.82–0.95)		0.97±0.02; (0.93–1.01)
	ied		2.61±0.10; (2.38–2.74)		2.84±0.08; (2.62–2.99)
	pl		1.58±0.06; (1.49–1.68)		1.75±0.08; (1.59–1.88)
Pronotum	haw	19	3.62±0.11; (3.44–3.75)	26	4.05±0.14; (3.77–4.33)
	aaw		3.17±0.10; (2.98–3.30)		3.52±0.11; (3.28–3.76)
	sl		4.09±0.16; (3.76–4.31)		4.73±0.16; (4.40–5.03)
Scutellum	fll	17	1.61±0.07; (1.44–1.70)	26	1.85±0.08; (1.70–2.02)
	pfl		2.48±0.11; (2.23–2.67)		2.88±0.11; (2.66–3.08)
	bsw		2.35±0.08; (2.20–2.46)		2.64±0.10; (2.43–2.79)
	fcw		1.57±0.06; (1.42–1.64)		1.86±0.09; (1.66–2.01)
	I		0.41±0.02; (0.37–0.43)		0.43±0.03; (0.40–0.47)
Antennae	II	10	0.41±0.02; (0.37–0.43)	10	0.44±0.02; (0.40–0.47)
	III		0.74±0.02; (0.71–0.78)		0.79±0.04; (0.74–0.87)
	IV		0.88±0.03; (0.84–0.93)		0.89±0.03; (0.84–0.93)
	V		1.12±0.04; (1.05–1.18)		1.12±0.05; (1.05–1.18)
	I		0.60±0.01; (0.59–0.62)		0.63±0.04; (0.59–0.68)
Labium	II	10	1.25±0.04; (1.18–1.30)	10	1.32±0.04; (1.24–1.36)
	III		0.52±0.03; (0.47–0.56)		0.56±0.03; (0.53–0.62)
	IV		0.35±0.02; (0.31–0.37)		0.36±0.02; (0.31–0.37)

Legend: tl, total length; mw, maximum width (at the sternite III level); hl, head length; cl, clypeus length; hw, head width; iod, interocellar distance; ied, interocular distance; pl, pronotum length; haw, pronotum width at the level of humeral angles; aaw, pronotum width at the level of anterolateral angles; sl, scutellum length; fll, frenal lobe length; pfl, post-frenal lobe length; bsw, basal scutellum width; fcw, scutellum width at the level of frenal constriction; I, II, III, IV and V, antennal and labium segments length.

curved ventrally; secondary gonopore ventrally directed and beveled (Fig. 9J–K).

Female. Membrane of hemelytra not reaching the posterior margin of mediotergite VIII; median portion of the posterior margin of mediotergite VIII and of sternite VII subrectilinear; projections on the lateral 1/3 of posterior margin of sternite VII laminate, semicircular and slightly oblique in relation to the sternite surface (Fig. 10C, mpr).

Genitalia. Valvifers VIII as long as wide, sutural angles subrectilinear, lateral angles slightly concave; sutural margins subrectilinear and dorsally folded; surface dark yellowish with brown punctures and setae on the distal half of the sutural margins; longitudinal grooves narrow and shallow at the basal portion (Figs. 5A; 10C, vf8). Valvifers IX almost completely covered by the valvifers VIII; lateral margin convex; setae on the mid-basal portion of the ventral surface (Fig. 10C–D, vf9). Laterotergites IX not reaching the posterior margin of mediotergite VIII; lateral margin convex; setae on the median portion of

the lateral margin and mid-basal portion of the ventral surface (Fig 10C–D, la9). Thickening of vaginal intima barrel-shaped, slightly wider than long; distal portion more sclerotized; lateral margins convex; distal margin sinuous with 1+1 processes on the laterals, ventrodistal cone with membranous subcircular apex (Fig. 10D, vi). Vesicular area: anterior portion to the collar 1/5 of the posterior portion; median duct anterior to the collar slightly widened (Fig. 10D, mdp); median duct posterior to the collar with proximal and distal widening (Fig. 10D, md); inner duct coiled in the proximal widening (Fig. 10D, id). Distal ductus receptaculi 0.54 times the length of vesicular area posterior to the collar (Fig. 10D, drd, drp). Pars intermedialis barrel shaped, longer than capsula seminalis (Fig. 10D, pi); annular crests convergent, diameter of the proximal crest slightly smaller than the distal one (Fig. 10D, dac, pac). Capsula seminalis with two filiform lateral projections, one long and sinuous and the other short and slightly

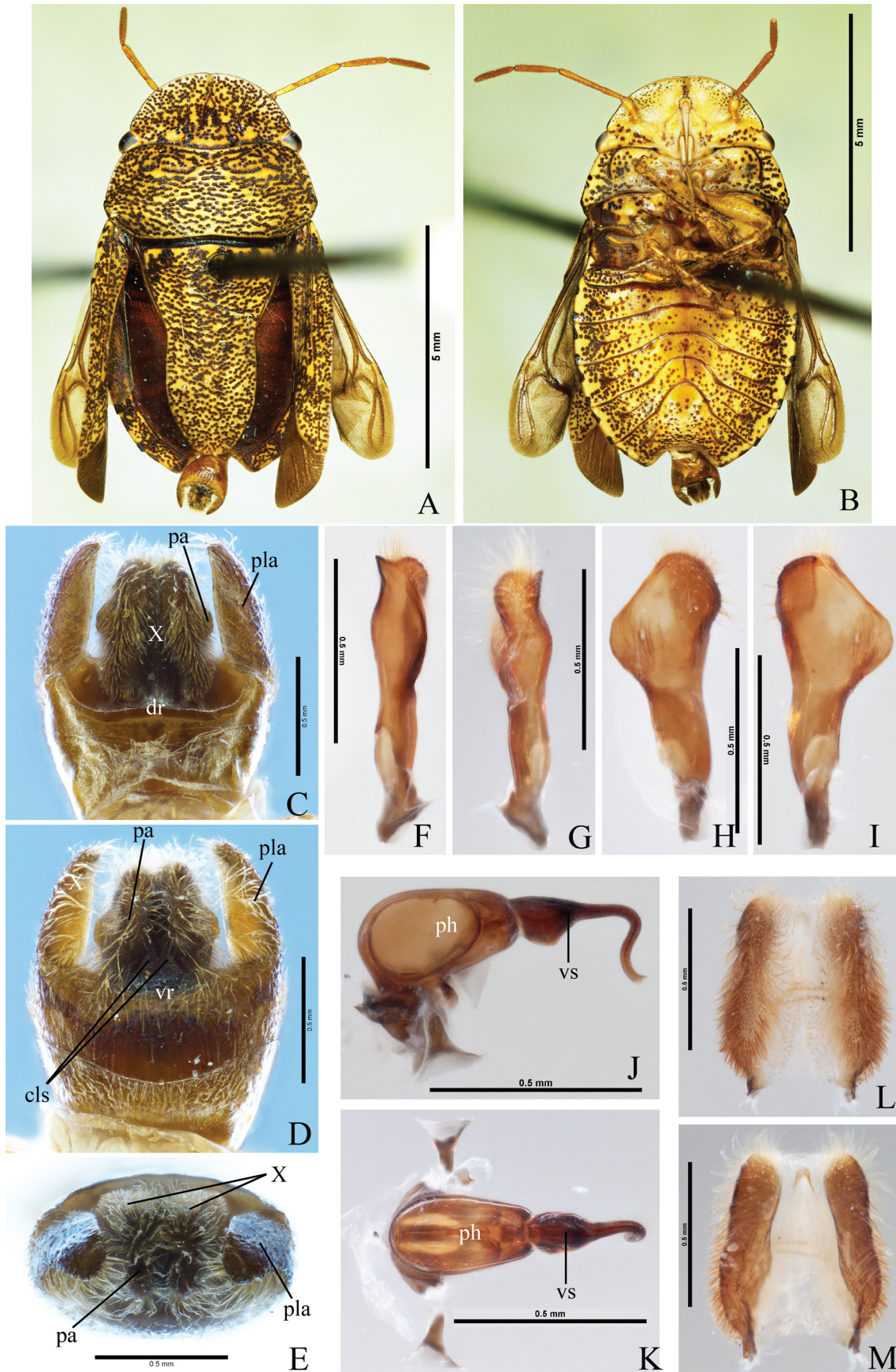

FIGURE 11. *Ischnopelta alalonga* Rosso & Campos, sp. n. Holotype male. A, dorsal view; B, ventral view; C–E, pygophore: dorsal, ventral, and posterior views respectively; F–I, parameters: dorsal, ventral, external and internal lateral views, respectively; J–K, phallus: lateral and dorsal views, respectively; L–M, segment X, dorsal and ventral views, respectively. Abbreviations: cls, cup like sclerites; dr, dorsal rim; pa, parameter; ph, phalloteca; pla, posterolateral angle; vr, ventral rim; vs, vesica; X, segment X.

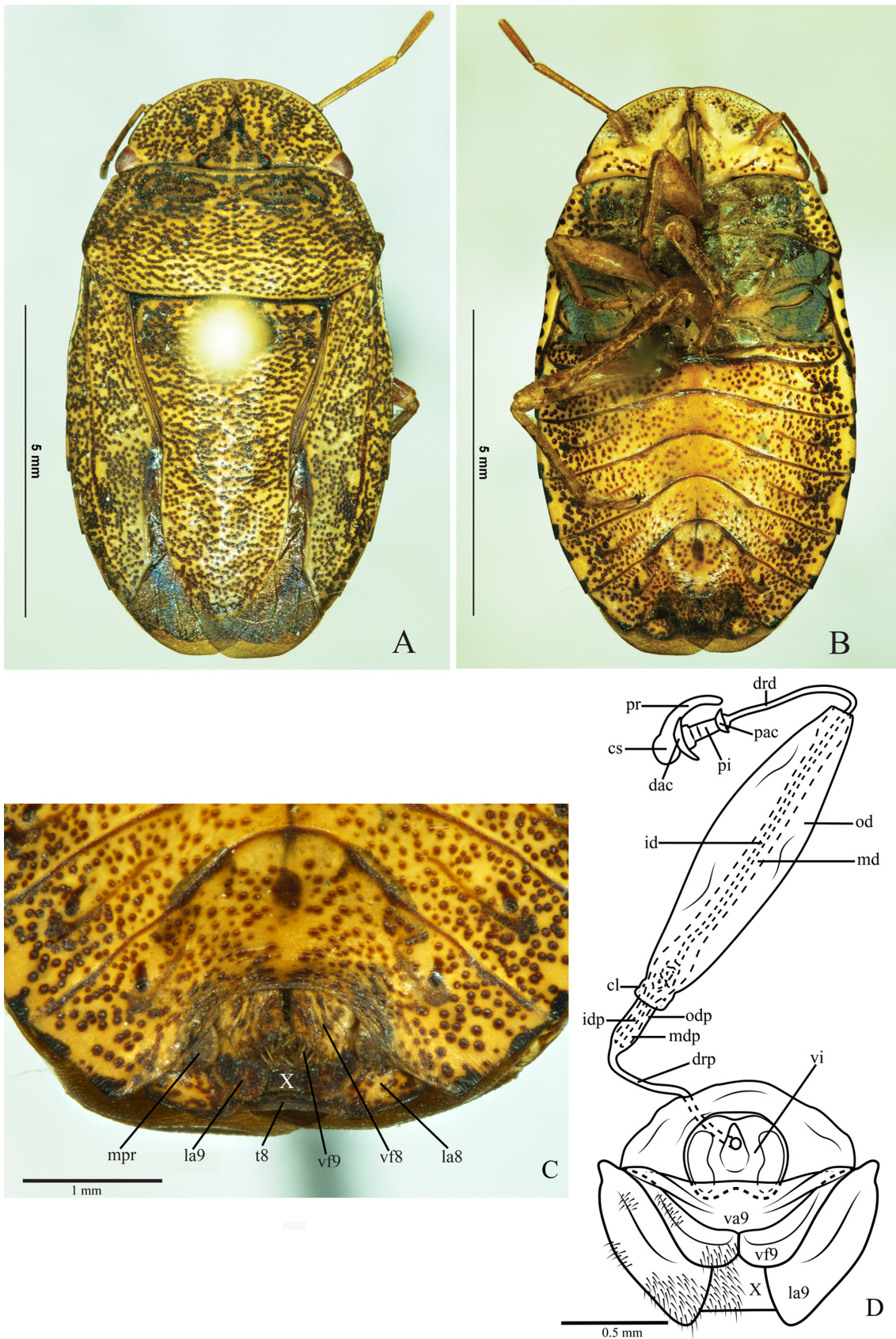

FIGURE 12. *Ischnopelta alalonga* Rosso & Campos, sp. n. Female. A, dorsal view; B, ventral view; C, genital plates ventroposterior view (45°); D, internal genitalia. Abbreviations: cl, collar; cs, seminalis capsule; dac, distal annular crest; drd, distal ductus receptaculi; drp, proximal ductus receptaculi; id, internal duct; idp, proximal internal duct; la8, laterotergite VIII; la9, laterotergite IX; md, medium duct; mdp, proximal medium duct; mpr, projection on the lateral third of posterior margin of sternite VII; od, external duct; odp, proximal external duct; pac, proximal annular crest; pi, pars intermedialis; pr, projection; t8, mediotergite VIII; va9, valvulae IX; vf8, valvifer VIII; vf9, valvifer IX; vi, thickening of vaginal intima; X, segment X.

curved, both directed to the pars intermedialis (Fig. 10D, cs, pr).

Measurements: Table 1.

Distribution. Venezuela, Brazil (Tocantins, Mato Grosso, Goiás, Minas Gerais, Brasília (DF), São Paulo) (Fig. 6).

Comments. Males of this species are easily recognized by the parameres aculeiform at apex, convergent and ventroposteriorly directed (observed in posterior view of the pygophore) (Fig. 9E, pa). Female identification is possible through the analysis of the posterior margin of valvifers VIII shaped as an open “V” with sutural angles subrectilinear and laterals slightly concave (Figs. 5A, vf8; 10C, vf8).

***Ischnopelta alalonga* Rosso & Campos, sp. n.** (Figs. 5O; 11–12)

Etymology. The epithet refers to the length of the wings, which in this species surpass the posterior margin of mediotergite VIII. Latin: *ala* = wing + *longus* = long.

Type locality. BRAZIL, *São Paulo*, Piracicaba [-22.7274, -47.6448].

Holotype. Male. BRAZIL, *São Paulo*, Piracicaba, 3.IX.1986, F.D. Bennett. Deposited at Museu de Zoologia da Universidade de São Paulo (MZSP), São Paulo (SP), Brazil.

Paratypes. 2 males and 14 females. BRAZIL, *São Paulo*, Piracicaba, 1 female, 3.IX.1986, F.D. Bennett, [-22.7274, -47.6448], (J.E. Eger, Personal collection); 3 females, 11.III.1987, F.D. Bennett, [-22.7274, -47.6448], (J.E. Eger, Personal collection); 1 female, 28.I.1988, D.H. Haback & F.D. Bennett, [-22.7274, -47.6448], (J.E. Eger, Personal collection); 1 male and 1 female, 20.II.1988, F.D. Bennett, [-22.7274, -47.6448], (J.E. Eger, Personal collection); Campinas (Campus UFU), 1 male and 2 females, 19.XI.1990, [-22.9095, -47.0674], (MZSP); 6 females, 19.XI.1990, [-22.9095, -47.0674], (UFRG).

Description. The overall somatic morphology is as described for *I. scutellata*, except for the following features. Head. Bucculae slightly higher than the first labial segment. Antennae yellow dorsally, and dark yellowish ventrally; segments ratio: I>II<III<IV<V.

Thorax. Pro-, meso- and metasternum not punctured. Evaporatorium not reaching the outer margin of mesopleura. Setae on posterodorsal margin of protibiae as long as the others.

Abdomen. Dark spots at the lateral of urosternites subtriangular, wide.

Male. Apical margin of membrane of hemelytra convex; urosternite VII not reaching anteriorly the imaginary line connecting the spiracles of urosternite V. **Genitalia.** Dorsal rim of pygophore sinuous (Fig. 11C, dr); ventral rim slightly concave (Fig. 11D, vr). Posterolateral angles 1.6 times longer than the rest of the pygophore, base and apex respectively perpendicular and oblique to the frontal plane, convergent from the base, dorsal margin folded into the pygophore (Fig. 11C–E, pla). Setae short on the posterior half of ventral and

lateral surfaces of the pygophore, and on the outer and inner surfaces of the posterolateral angles; setae long and dense on the lateral portions of the ventral rim, and on the ventral and apical margins of the posterolateral angles. Segment X longer than wide, surpassing the parameres, but not reaching the apex of the posterolateral angles, subrectilinear and strongly emarginated apically; lateral margins sclerotized and densely covered with long setae; mid-longitudinal region membranous and with sparse setae (Figs. 11C and E, X; 11L–M). Parameres club-shaped, swollen, and perpendicular to the frontal plane; inner and outer surfaces sinuous, distal portion of inner surface slightly concave, with transverse lines and a minute apical process; ventral surface sinuous; dorsal surface narrow, distal half strongly convex longitudinally; setae covering the apex (Figs. 11D, pa; 11F–I). Cup-like sclerites externally visible and with apices rounded and slightly convergent (Fig. 11D, cls). Phallus: proximal portion of vesica laterally biconcave, ventrally expanded; median portion subcylindrical, gradually narrowed and bent ventrally; distal portion subcylindrical and sinuous; secondary gonopore ventroposterior and beveled (Fig. 11J–K).

Female. Hemelytral membrane surpassing the posterior margin of mediotergite VIII, posterior margin convex; median portion of posterior margin of urosternite VII, and projections on its lateral 1/3 (Fig. 12C, mpr) as described for *I. scutellata*. **Genitalia.** Valvifers VIII wider than long; posterior margin strongly sinuous, sutural portion slightly convex; lateral portion sinuous, slightly oblique to the midline and with slender cut on the lateral; sutural margins subrectilinear and folded dorsally; surface dark yellowish with brown punctures and setae on the distal half of the sutural margins and on the posterior margin; longitudinal grooves narrow and shallow at the basal portion (Figs. 5O; 12C, vf8). Valvifers IX exposed; lateral margin subrectilinear; setae on mid-basal portion of ventral surface (Fig. 12C–D, vf9). Laterotergites IX not reaching the posterior margin of mediotergite VIII; lateral margin convex; setae on median portion of lateral margin and on mid-basal portion of the ventral surface (Fig. 12C–D, la9). Thickening of vaginal intima subcircular, slightly wider than long; proximal margin concave and wider than the distal one; distal margin weakly emarginated; mid-ventral area with membranous elliptical cone, dorsal longitudinal ridges divergent distally and reaching the margins (Fig. 12D, vi). Vesicular area: anterior portion to the collar 1/6.5 of the posterior portion; median duct anterior to the collar with slight proximal widening (Fig. 12D, mdp); median duct posterior to the collar with proximal and distal widening (Fig. 12D, md); inner duct coiled in the proximal widening (Fig. 12D, id). Distal ductus receptaculi 0.40 times the length of the vesicular area posterior to the collar (Fig. 12D, drd, drp). Pars intermedialis wider distally (Fig. 12D, pi); proximal annular crest perpendicular to pars intermedialis, the distal one facing the pars intermedialis and almost twice the size the proximal (Fig. 12D, dac, pac). Capsula seminalis globose, with a long and sinuous laterobasal projection directed to the pars intermedialis;

TABLE 2. Measurements (mean, standard deviation, minimum and maximum) and number of *Ischnopelta alalonga* Rosso & Campos, sp. n. specimens evaluated (n).

Body structure	Measurements performed	Male		Female	
		n	Measurements (mm)	n	Measurements (mm)
Body	tl	3	8.44±0.17; (8.32–8.63)	15	9.53±0.29; (8.96–10.06)
	mw		4.82±0.10; (4.74–4.94)		5.36±0.08; (5.27–5.51)
Head	hl		1.82±0.06; (1.75–1.86)		1.88±0.07; (1.75–1.98)
	cl		0.59±0.03; (0.56–0.62)		0.66±0.03; (0.60–0.70)
	hw	3	3.76±0.05; (3.73–3.82)	15	3.97±0.14; (3.76–4.24)
	iod		1.01±0.03; (0.98–1.03)		1.09±0.03; (1.03–1.13)
	ied		3.03±0.01; (3.02–3.04)		3.21±0.12; (3.02–3.45)
Pronotum	pl		1.88±0.05; (1.83–1.93)		2.08±0.05; (1.99–2.19)
	haw	3	4.49±0.05; (4.44–4.54)	15	4.89±0.13; (4.57–5.03)
	aaw		3.67±0.03; (3.65–3.70)		3.98±0.11; (3.74–4.13)
Scutellum	sl		4.77±0.17; (4.58–4.90)		5.35±0.12; (5.11–5.52)
	fll		1.96±0.06; (1.89–2.00)		2.21±0.09; (1.94–2.38)
	pfl	3	2.81±0.20; (2.59–2.94)	15	3.14±0.10; (2.97–3.32)
	bsw		2.84±0.04; (2.81–2.88)		3.17±0.09; (3.00–3.27)
	fcw		1.98±0.22; (1.84–2.24)		2.15±0.07; (1.99–2.23)
Antennae	I		0.55±0.02; (0.53–0.56)		0.54±0.03; (0.50–0.59)
	II	3	0.47±0.00; (0.47–0.47)	11	0.49±0.02; (0.47–0.53)
	III		0.95±0.02; (0.93–0.96)		0.93±0.03; (0.87–0.99)
	IV		1.06±0.02; (1.05–1.09)		1.04±0.03; (0.99–1.09)
	V	1	1.24	9	1.22±0.03; (1.18–1.27)
Labium	I		0.63±0.02; (0.62–0.65)		0.66±0.03; (0.62–0.71)
	II	3	1.33±0.03; (1.30–1.36)	11	1.33±0.05; (1.27–1.40)
	III		0.51±0.02; (0.50–0.53)		0.60±0.02; (0.59–0.65)
	IV		0.39±0.02; (0.37–0.40)	10	0.38±0.02; (0.34–0.40)

Legend: tl, total length; mw, maximum width (at the sternite III level); hl, head length; cl, clypeus length; hw, head width; iod, interocellar distance; ied, interocular distance; pl, pronotum length; haw, pronotum width at the level of humeral angles; aaw, pronotum width at the level of anterolateral angles; sl, scutellum length; fll, frenal lobe length; pfl, post-frenal lobe length; bsw, basal scutellum width; fcw, scutellum width at the level of frenal constriction; I, II, III, IV and V, antennal and labium segments length.

in some specimens, a lateral projection of variable size may occur (Fig. 12D, cs, pr).

Measurements: Table 2.

Distribution. Brazil (São Paulo) (Fig. 6).

Comments. *Ischnopelta alalonga* sp. n. (Figs. 11A–B; 12A–B), although similar to *Ischnopelta crassula* sp. n. (Figs. 23A–B; 23A–B), presents the corium slightly shorter than the scutellum, and the lateral abdominal stripe unpunctured, better delimited and with dark-brown blotches, whilst in *I. crassula* the corium and scutellum are subequal, and the lateral abdominal stripe presents, besides the blotches, few irregularly distributed punctures. The dorsal rim of the pygophore is sinuous in *I. alalonga* (Fig. 11C, dr) and slightly concave in *I. crassula* (Fig. 22C, dr), the parameres with more developed apical process, and the area with differentiated texture in the inner surface is longer and narrow in *I. alalonga* (Figs. 11F–I; 22F–I); the proximal portion of vesica is laterally biconvex in *I. alalonga* (Fig. 11K, vs), while in *I. crassula* it is wider at

the base and gradually narrows up to the curvature (Fig. 22K, vs). The female hemelytral membrane surpasses the posterior margin of mediotergite VIII in *I. alalonga* (Fig. 12A–B), but not in *I. crassula* (Fig. 23A–B). The thickening of the vaginal intima forms a median and elliptical membranous cone, and the dorsal longitudinal ridges are sinuous and divergent distally reaching the margins in *I. alalonga* (Fig. 12D, iv), while in *I. crassula* the cone is subtriangular, and the ridges are sinuous and not reaching the margins (Fig. 23D, iv).

***Ischnopelta anangulata* Rosso & Campos, sp. n.** (Figs. 4C and 13)

Etymology. The epithet refers to the absence of the posterolateral angles of the pygophore. Latin: *a-*, *an-* = not, without (absent) + *angularis*, *-tus* = with angles.

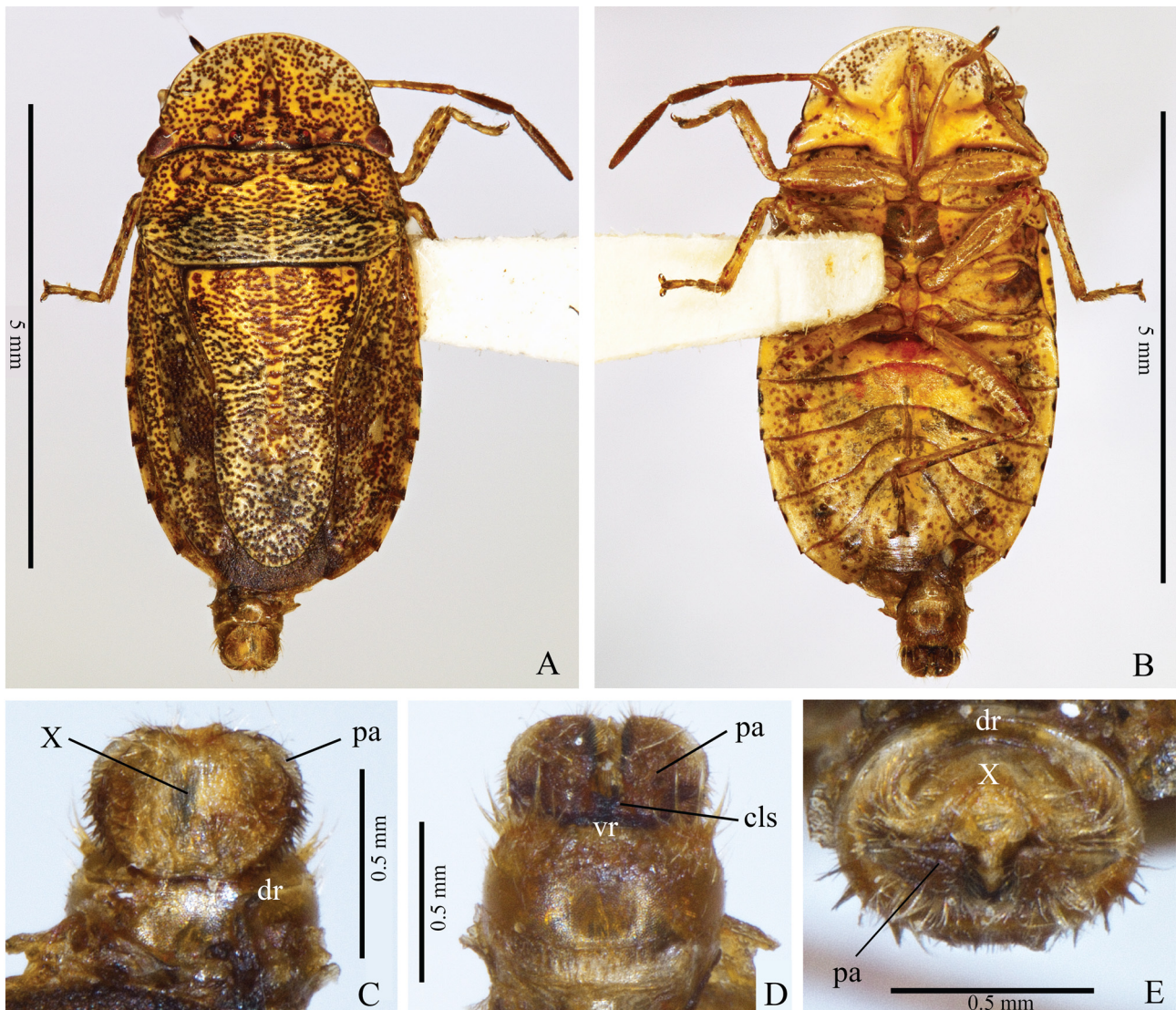

FIGURE 13. *Ischnopelta anangulata* Rosso & Campos, sp. n. Holotype male. A, dorsal view; B, ventral view; C–E, pygophore: dorsal, ventral and posterior views respectively. Abbreviations: cls, cup like sclerites; dr, dorsal rim; pa, parameter; vr, ventral rim; X, segment X.

TABLE 3. Measurements and number of *Ischnopelta anangulata* Rosso & Campos, sp. n. specimens evaluated (n).

Body structure	Measurements performed	Male		Female	
		n	Measurements (mm)	n	Measurements (mm)
Body	tl	1	6.15	–	–
	mw		3.27	–	–
Head	hl	1	1.44	–	–
	cl		0.50	–	–
	hw		2.71	–	–
	iod		0.79	–	–
	ied		2.13	–	–
Pronotum	pl	1	1.26	–	–
	haw		2.99	–	–
	aaw		2.67	–	–

...Continued on the next page

TABLE 3. (Continued)

Body structure	Measurements performed	Male		Female	
		n	Measurements (mm)	n	Measurements (mm)
Scutellum	sl		3.35		–
	flf		1.25		–
	pfl	1	2.10	–	–
	bsw		1.96		–
	fcw		1.32		–
Antennae	I		0.43		–
	II		0.34		–
	III	1	0.71	–	–
	IV		0.78		–
	V		1.02		–
Labium	I		0.56		–
	II		1.30		–
	III	1	0.56	–	–
	IV		0.31		–

Legend: tl, total length; mw, maximum width (at the sternite III level); hl, head length; cl, clypeus length; hw, head width; iod, interocellar distance; ied, interocular distance; pl, pronotum length; haw, pronotum width at the level of humeral angles; aaw, pronotum width at the level of anterolateral angles; sl, scutellum length; flf, frenal lobe length; pfl, post-frenal lobe length; bsw, basal scutellum width; fcw, scutellum width at the level of frenal constriction; I, II, III, IV and V, antennal and labium segments length.

Type locality. BRAZIL, *Minas Gerais*, Pirapora [-17.3374, -44.9271].

Holotype. Male. BRAZIL, *Minas Gerais*, Pirapora, XI.1975, M. Alvarenga. Deposited at the Museu de Zoologia da Universidade de São Paulo (MZSP), São Paulo (SP), Brazil.

Description. The overall somatic morphology is as described for *I. scutellata*, except for the following features. Head. Anterior margin not emarginated. Ocular peduncles scarcely punctured. Antennae: segment I and dorsal surface of segments II and III dark yellowish, the latter brown stained; ventral surface of segments II to V brown; segments ratio: I>II<III<IV<V.

Thorax. Hemelytra: corium as long as scutellum; conspicuous spot at apex of radial vein; radial vein continued by a reddish line. Distal 1/3 of femora and tibiae punctures, some punctures larger than the rest of the body; setae on posterodorsal margin of protibiae as long as the others.

Abdomen. Posterolateral angles of urosternite VII unarmed.

Male. Apical margin of hemelytral membrane convex; urosternite VII reaching anteriorly the imaginary line connecting the spiracles of urosternite V. **Genitalia.** Dorsal rim of pygophore sinuous, slightly convex on the median portion (Fig. 13C, dr); ventral rim sinuous, median portion dark-brown and iridescent (Fig. 13D, vr). Posterolateral angles not developed. Setae short on the median portion of ventral rim and 1 + 1 tufts of long setae on the lateral portions. Segment X wider than long; cordiform and apically emarginated; lateral margins sclerotized and covered by setae; median region

membranous (Fig. 13C, X). Parameres with flat head, shaped as 1/4 circumference; oblique to the frontal plane; inner margin subrectilinear and strongly sclerotized; ventral surface convex and covered by long setae (Fig. 13D–E, pa). Phallus not examined.

Female. Unknown.

Measurements: Table 3.

Distribution. Brazil (Minas Gerais) (Fig. 6).

Comments. *Ischnopelta anangulata* can be easily recognized by the apex of the head is not emarginated (Fig. 13A–B), the short dorsal surface of pygophore with no development of posterolateral angles (Fig. 13C–D), and the parameres and segment X caudally projected and surpassing the ventral rim of pygophore (Fig. 13D, pa, vr).

***Ischnopelta bechyneorum* Rosso & Campos, sp. n.** (Figs. 4A, 5B, 14–15)

Etymology. Epithet in honor to Jan Karel Bechyné and Bohumila Springlová Bechyné who worked at the Museu Paraense Emilio Goeldi between 1960 and 1963. Although they were specialists on the beetle family Chrysomelidae, they collected many other insect groups, including specimens of this and five other species included in the present study.

Type locality. BRAZIL, *Mato Grosso*, Chapada dos Guimarães [-15.4610, -55.75].

Holotype. Male. BRAZIL, *Mato Grosso*, Chapada dos Guimarães, 2.II.1961, J. & B. Bechyné. Deposited at the Museu Paraense Emilio Goeldi (MPEG), Belém (PA), Brazil.

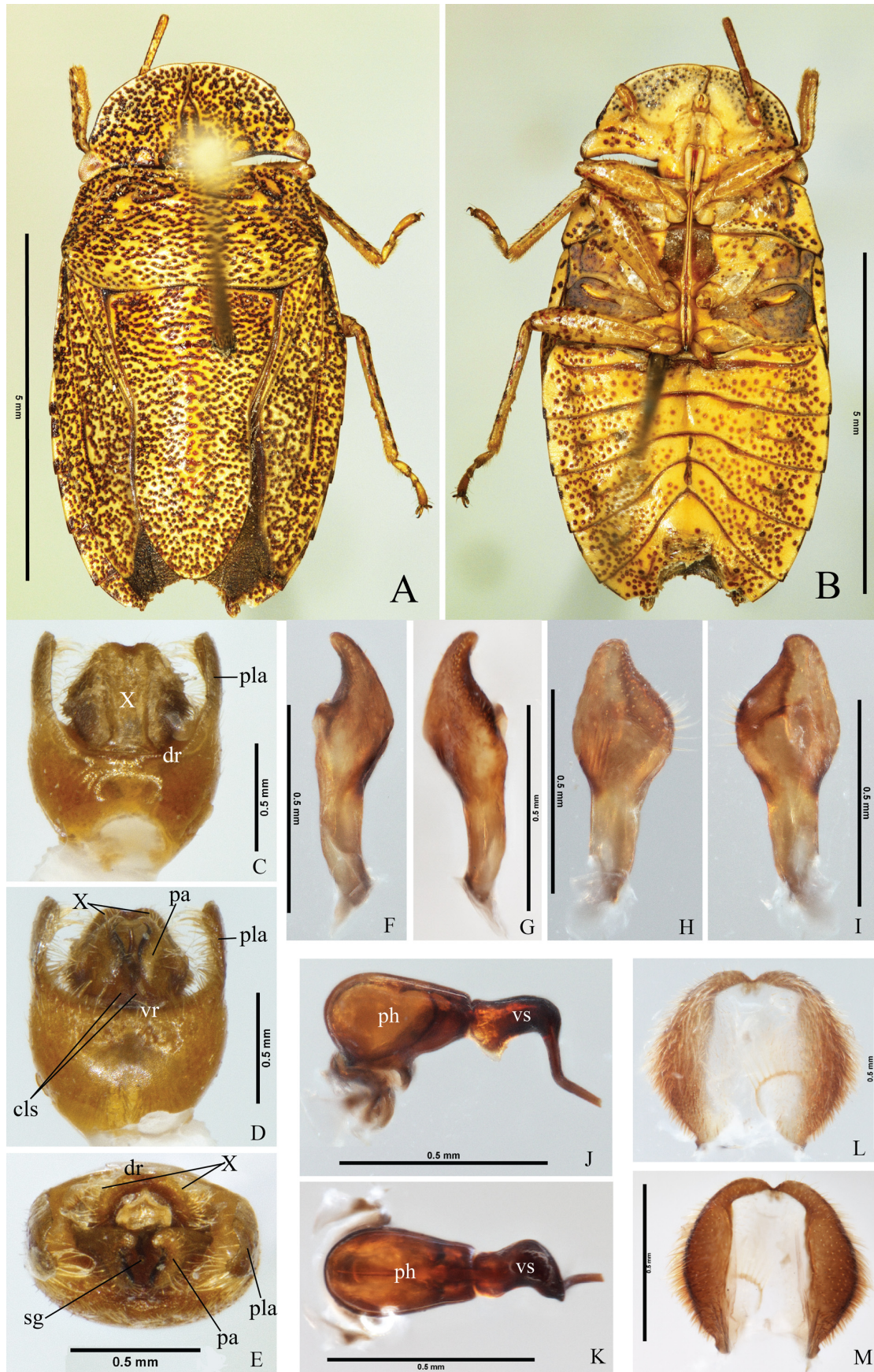

FIGURE 14. *Ischnopelta bechyneorum* Rosso & Campos, sp. n. Holotype male. A, dorsal view; B, ventral view; C–E, pygophore: dorsal, ventral, and posterior views respectively; F–I, parameters: dorsal, ventral, external and internal lateral views, respectively; J–K, phallus: lateral and dorsal views, respectively; L–M, segment X, dorsal and ventral views, respectively. Abbreviations: cls, cup like sclerites; dr, dorsal rim; pa, parameter; ph, phalloteca; pla, posterolateral angle; sg, secondary gonopore aperture; vr, ventral rim; vs, vesica; X, segment X.

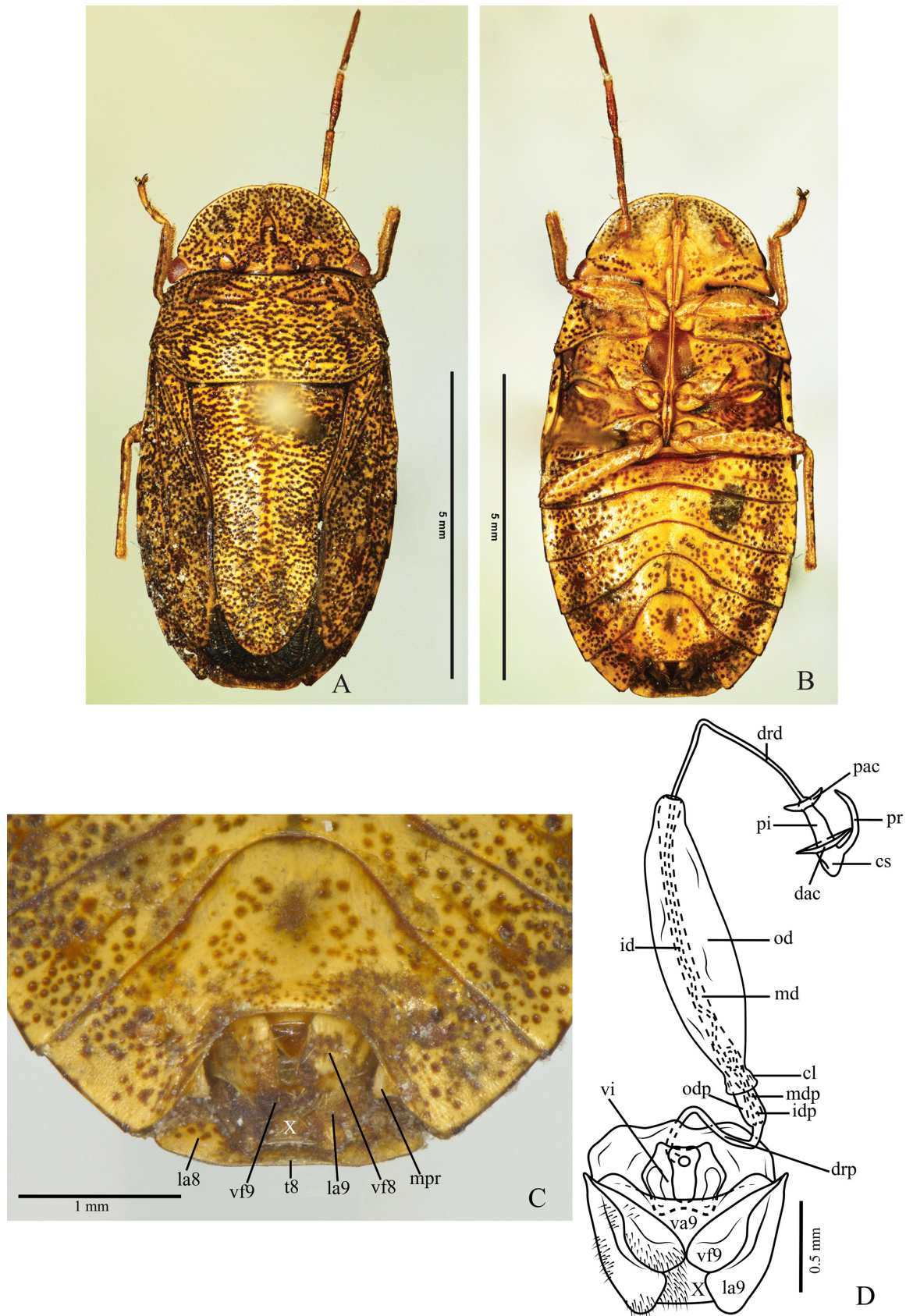

FIGURE 15. *Ischnopelta bechyneorum* Rosso & Campos, sp. n. Female. A, dorsal view; B, ventral view; C, genital plates ventroposterior view (45°); D, internal genitalia. Abbreviations: cl, collar; cs, seminalis capsule; dac, distal annular crest; drd, distal ductus receptaculi; drp, proximal ductus receptaculi; id, internal duct; idp, proximal internal duct; la8, laterotergite VIII; la9, laterotergite IX; md, medium duct; mdp, proximal medium duct; mpr, projection on the lateral third of posterior margin of sternite VII; od, external duct; odp, proximal external duct; pac, proximal annular crest; pi, pars intermedialis; pr, projection; t8, mediotergite VIII; va9, valvulae IX; vf8, valvifer VIII; vf9, valvifer IX; vi, thickening of vaginal intima; X, segment X.

Paratypes. 3 males and 4 females. BRAZIL, *Mato Grosso*, Chapada do Guimarães, 2 females, 2.II.1961, J. & B. Bechyné, [-15.4610, -55.75], (MPEG); *Mato Grosso do Sul*, Três Lagoas, (Água Tirada), 1 male, 15–30.V.1964, Exp. Dpto. Zool., [-20.8, -51.7167], (MZSP); Três Lagoas (Fazenda Dr. José Mendes), 1 male and 1 female, 14–24.X.1964, Exp. Dpto. Zool., [-20.8, -51.7167], (UFRG); Três Lagoas, (left margin of Rio Sucuriu, Fazenda Canaã), 1 male, XI.1966, F. Lane Col., [-20.8, -51.7167], (UFRG); no information about locality, 1 female, VIII.1931, (MCNZ).

Description. The overall somatic morphology is as described for *I. scutellata*, except for the following features. Head. Maxillary plates and ocular peduncles scarcely punctured. Antennae: segment I and dorsal surface of segments II and III dark yellowish and punctured; ventral surface of segments II to V brown; antennal segments ratio: I>II<II<IV<V.

Thorax. Pronotum slightly longer than the head. Hemelytra: corium as long as scutellum; conspicuous

spot at apex of radial vein; in most specimens the radial vein is continued by a reddish line. Pro-, meso- and metasternum moderately punctured. Evaporatorium densely punctured.

Male. Apical margin of hemelytral membrane convex; urosternite VII reaching anteriorly the imaginary line connecting the spiracles of sternite V. **Genitalia.** Pygophore with dorsal and ventral rim concave (Figs. 14C, dr; 14D, vr). Posterolateral angles 1.3 times longer than the rest of the pygophore, perpendicular to the frontal plane and subparallel to each other (Fig. 14C–E, pla). Setae short and sparse on the posterior half of ventral and lateral surfaces of the pygophore, and on the outer surface of posterolateral angles; setae long on ventral rim and on ventral margin of the posterolateral angles. Segment X as long as wide, dorsally covering the parameres, but not reaching the apex of posterolateral angles; subcircular and emarginated apically; lateral and apical margins sclerotized and covered by long setae; extensive mid-longitudinal area membranous and with short and sparse

TABLE 4. Measurements (mean, standard deviation, minimum and maximum) and number of *Ischnopelta bechyneorum* Rosso & Campos, sp. n. specimens evaluated (n).

Body structure	Measurements performed	Male		Female	
		n	Measurements (mm)	n	Measurements (mm)
Body	tl	4	6.99±0.64; (6.38–7.87)	4	8.27±0.19; (8.01–8.42)
	mw		3.88±0.32; (3.55–4.28)		4.45±0.06; (4.39–4.51)
Head	hl		1.46±0.09; (1.37–1.57)		1.66±0.03; (1.63–1.70)
	cl		0.55±0.04; (0.49–0.59)		0.56±0.03; (0.52–0.60)
	hw	4	3.16±0.15; (3.05–3.38)	4	3.46±0.05; (3.41–3.52)
	iod		0.86±0.04; (0.81–0.90)		0.96±0.03; (0.91–0.99)
	ied		2.50±0.14; (2.37–2.69)		2.75±0.03; (2.72–2.78)
Pronotum	pl		1.56±0.15; (1.40–1.76)		1.79±0.06; (1.70–1.83)
	haw	4	3.57±0.23; (3.34–3.88)	4	4.06±0.09; (3.97–4.17)
	aaw		3.08±0.17; (2.96–3.32)		3.45±0.08; (3.36–3.55)
Scutellum	sl		3.84±0.27; (3.55–4.18)		4.55±0.17; (4.35–4.75)
	fll		1.56±0.12; (1.46–1.74)		1.93±0.04; (1.90–1.97)
	pfl	4	2.28±0.16; (2.09–2.45)	4	2.62±0.14; (2.44–2.78)
	bsw		2.28±0.18; (2.08–2.50)		2.63±0.06; (2.57–2.70)
	fcw		1.50±0.16; (1.34–1.68)		1.79±0.09; (1.68–1.88)
Antennae	I		0.41±0.02; (0.40–0.43)		0.46±0.02; (0.43–0.47)
	II	4	0.42±0.04; (0.40–0.47)	4	0.47±0.03; (0.43–0.50)
	III		0.75±0.02; (0.74–0.78)		0.77±0.04; (0.71–0.81)
	IV	1	0.93		0.91±0.03; (0.87–0.93)
	V		1.21	2	1.19±0.02; (1.18–1.21)
Labium	I		0.62±0.03; (0.59–0.65)		0.64±0.02; (0.62–0.65)
	II	3	1.26±0.02; (1.24–1.27)	4	1.37±0.04; (1.33–1.43)
	III		0.48±0.02; (0.47–0.50)		0.53±0.00; (0.53–0.53)
	IV		0.32±0.02; (0.31–0.34)		0.37±0.03; (0.34–0.40)

Legend: tl, total length; mw, maximum width (at the sternite III level); hl, head length; cl, clypeus length; hw, head width; iod, interocellar distance; ied, interocular distance; pl, pronotum length; haw, pronotum width at the level of humeral angles; aaw, pronotum width at the level of anterolateral angles; sl, scutellum length; fll, frenal lobe length; pfl, post-frenal lobe length; bsw, basal scutellum width; fcw, scutellum width at the level of frenal constriction; I, II, III, IV and V, antennal and labium segments length.

setae (Figs. 14C and E, X; 14L–M). Parameres falciform, flat and oblique to the frontal plane; outer and inner margins sinuous, distal portion of inner margin with minute process followed by concavity; apices truncated and convergent (Fig. 14F–I). Cup-like sclerites externally visible and divergent at apex (Fig. 14D, cls). Phallus: proximal half of vesica laterally sinuous, broader at the base and gradually narrowing, with a subtriangular ventral expansion; distal half sinuous, ventroposteriorly curved; secondary gonopore posteriorly directed and beveled (Fig. 14J–K).

Female. Membrane of hemelytra not reaching the posterior margin of mediotergite VIII, posterior margin convex. **Genitalia.** Valvifers VIII wider than long, posterior margin shaped as an open “V”, sutural angles narrow and subrectilinear, lateral angles wide and concave; sutural angles about 0.3 times the width of the lateral ones; sutural margins subrectilinear; surface convex, dark yellowish; brown punctures and setae on distal half of the sutural margins and sutural angles (Figs. 5B; 15C, vf8). Valvifers IX exposed, lateral margin sinuous; setae on the mid-basal portion of ventral surface (Fig. 15C–D, vf9). Laterotergites IX not reaching the posterior margin of mediotergite VIII; lateral margin convex; setae on median portion of lateral margin and on mid-basal portion of ventral surface (Fig. 15C–D, la9). Thickening of vaginal intima hexagonal, wider than long; distal margin sinuous and more sclerotized; extensive mid-longitudinal area membranous (Fig. 15D, vi). Vesicular area: anterior portion to the collar 1/8 the length of the posterior portion; median duct anterior to the collar with slight proximal widening (Fig. 15D, mdp), median duct posterior to the collar with proximal and distal widening (Fig. 15D, md), inner duct coiled in the proximal widening (Fig. 15D, id). Distal ductus receptaculi 0.7 times the length of the vesicular area posterior to the collar (Fig. 15D, drd, drp). Pars intermedialis broader distally (Fig. 15D, pi); proximal annular crest directed to the ductus receptaculi, the distal one directed to the pars intermedialis and slightly larger than the proximal (Fig. 15D, dac, pac). Capsula seminalis globose, with a long filiform lateral projection and a minute one, both directed to the pars intermedialis (Fig. 15D, cs, pr).

Measurements: Table 4.

Distribution. Brazil (Mato Grosso, Mato Grosso do Sul) (Fig. 6).

Comments. *Ischnopelta bechyneorum* (Figs, 14A–B; 15A–B) is similar to *I. scutellata* (Figs, 9A–B; 10A–B). On males, the apex of parameres is truncated and the segment X is subcircular in *I. bechyneorum* (Figs. 14F–I; 14L–M), while in *I. scutellata* the apex of parameres is aculeiform and the segment X is subrectangular (Figs. 9F–I; 9L–M). On females, although the posterior margin of valvifers VIII is shaped as an open “V” on both, in *I. bechyneorum* the sutural angles are convex (Figs. 5B; 15C, vf8), while in *I. scutellata* they are subrectilinear (Fig. 5A; 10C, vf8).

Ischnopelta confusa Rosso & Campos, sp. n. (Figs. 5C, 16–17)

Etymology. Epithet proposed by Dr. H. Ruckes as registered in the manuscripts found with the specimens used in the study. He considered the species could be easily confounded with *I. scutellata*, from which the epithet is inferred. Latin: *confusio* = mixture, disorder.

Type locality. ARGENTINA, *Formosa*, Formosa [-26.366667, -58.583333].

Holotype. Male. ARGENTINA, *Formosa*, Formosa (45 km SW Formosa), 28.I.1989, C.W. & L.B. O’Brien & G. Wibmer. Deposited at Museo Argentino de Ciencias Naturales “Bernardino Rivadavia” (MACN), Buenos Aires, Argentina.

Paratypes. 3 males and 4 females. ARGENTINA, *Misiones*, Loreto, 2 males and 2 females, IX.1954, [-27.3364, -55.5222], (AMNH); 1 female, XII.1955, [-27.3364, -55.5222], (UFRG); Santa Maria, 1 male and 1 female, XI.1962, M.J. Viana, [-27.9036, -55.3854], (MACN).

Description. The overall somatic morphology is as described for *I. scutellata*, except for the following features. Dorsal body surface brownish.

Head. Labium reaching the metacoxae. Labrum inserted posterior to half the distance between the anterior margin of the eyes and the apex of mandibular plates. Antennae: segments I to III dark yellowish, segments IV and V dark brown; segments ratio: I>II<III≤IV<V.

Thorax. Hemelytra: conspicuous spot at apex of radial vein. Pro-, meso- and metapleura densely punctured. Setae on posterodorsal margin of protibiae as long as the others.

Abdomen. Dark spots at the lateral of urosternites wide and irregularly shaped.

Male. Apical margin of the membrane of hemelytra subrectilinear; urosternite VII not reaching anteriorly the imaginary line between the spiracles of sternite V; posterolateral angles of urosternite VII unarmed.

Genitalia. Dorsal rim of pygophore concave, ventral rim slightly concave (Figs. 16C, dr; 16D, vr) with 1 + 1 lateral subtriangular projections (Fig. 16C–E, pr). Posterolateral angles almost as long as the rest of the pygophore, perpendicular to the frontal plane and subparallel to each other (Fig. 16C–E, pla). Setae short and sparse on posterior half of ventral and lateral surfaces of the pygophore, and on the outer surface of posterolateral angles; long setae on ventral rim, forming a 1 + 1 tufts on median portion; setae on the inner surface of posterolateral angles. Segment X slightly wider than long, surpassing the apex of posterolateral angles and parameres; apical margin subrectilinear; lateral margins strongly convex; basal and apical margins and mid-basal regions membranous; covered by long setae (Fig. 16L–M). Parameres spatulate, flat, longer than posterolateral angles and subparallel to the frontal lobe; outer margin sinuous on proximal half and strongly convex on distal half; inner margin sinuous, distal portion with a recession followed by a short process, truncate and convergent; apical margin convex; head ventral surface with an oblique crest, setose (Fig. 16F–I).

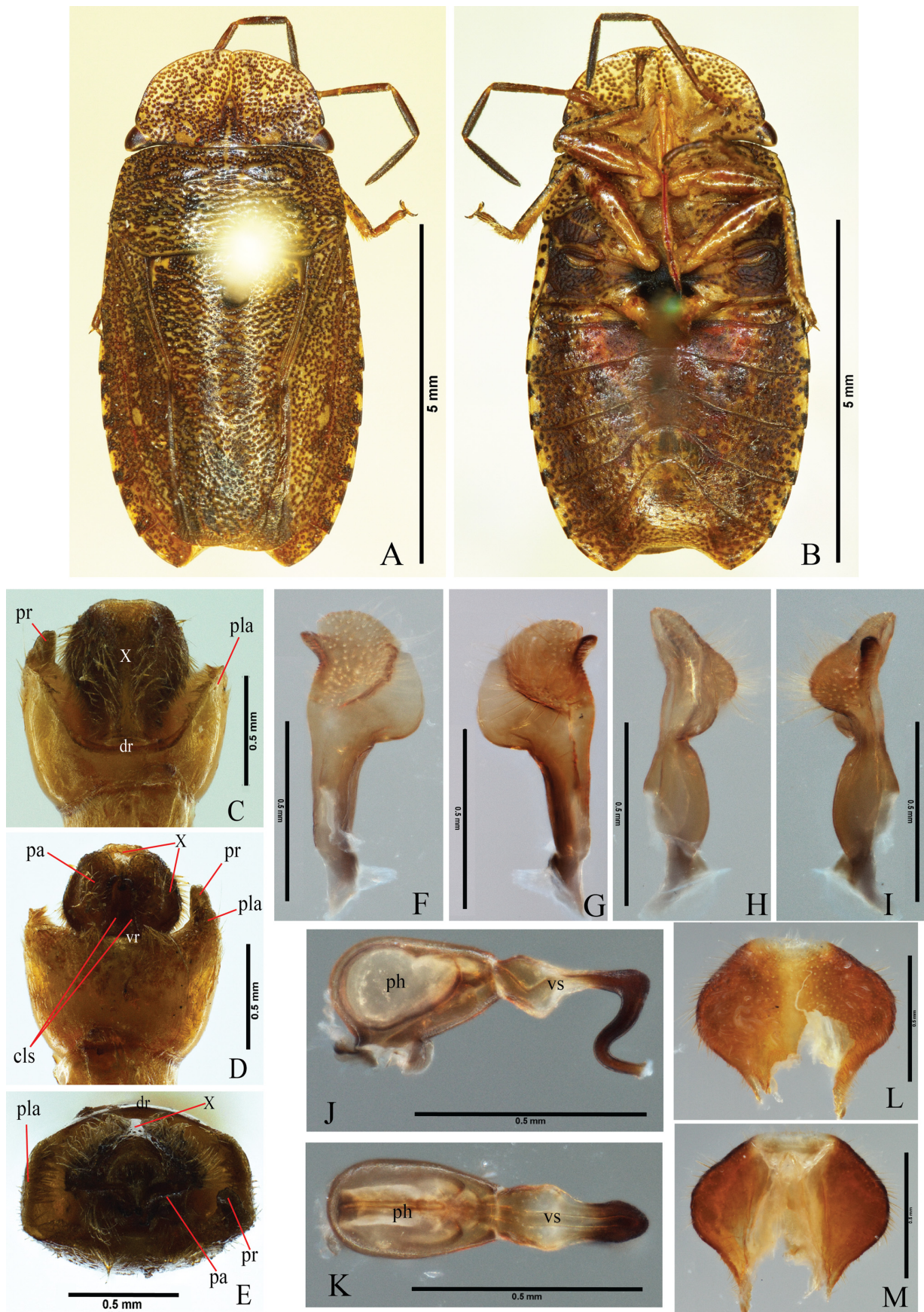

FIGURE 16. *Ischnopelta confusa* Rosso & Campos, sp. n. Holotype male. A, dorsal view; B, ventral view; C–E, pygophore: dorsal, ventral, and posterior views respectively; F–I, parameters: dorsal, ventral, external and internal lateral views, respectively; J–K, phallus: lateral and dorsal views, respectively; L–M, segment X, dorsal and ventral views, respectively. Abbreviations: cls, cup like sclerites; dr, dorsal rim; pa, parameter; ph, phalloteca; pla, posterolateral angle; pr, ventral rim projection; vr, ventral rim; vs, vesica; X, segment X.

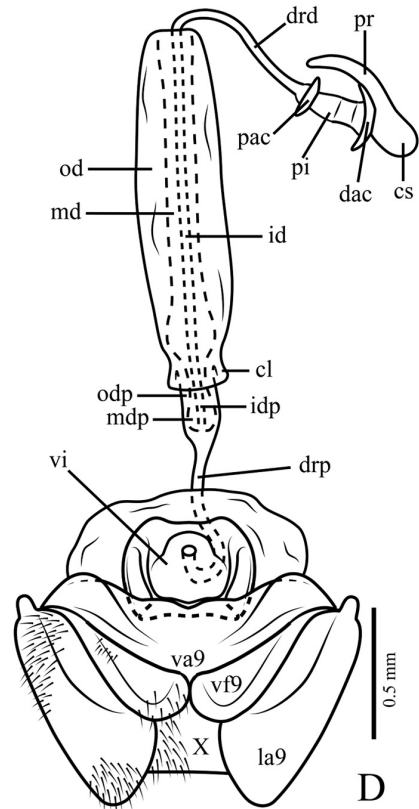
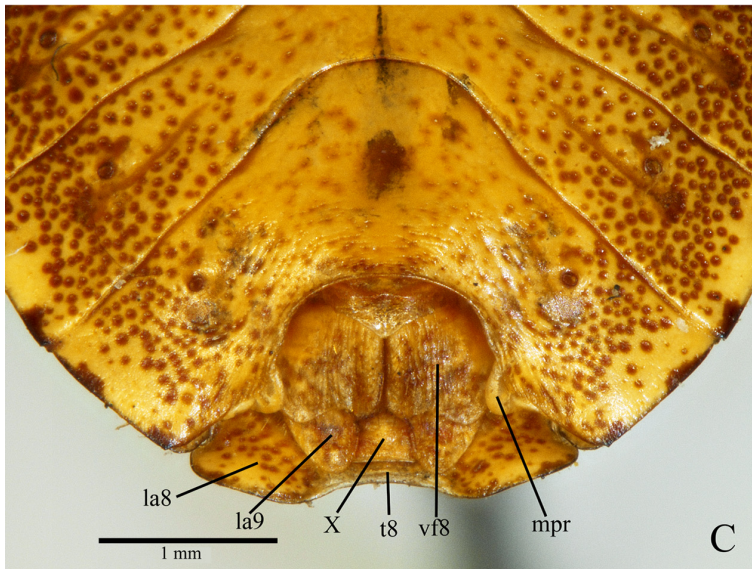
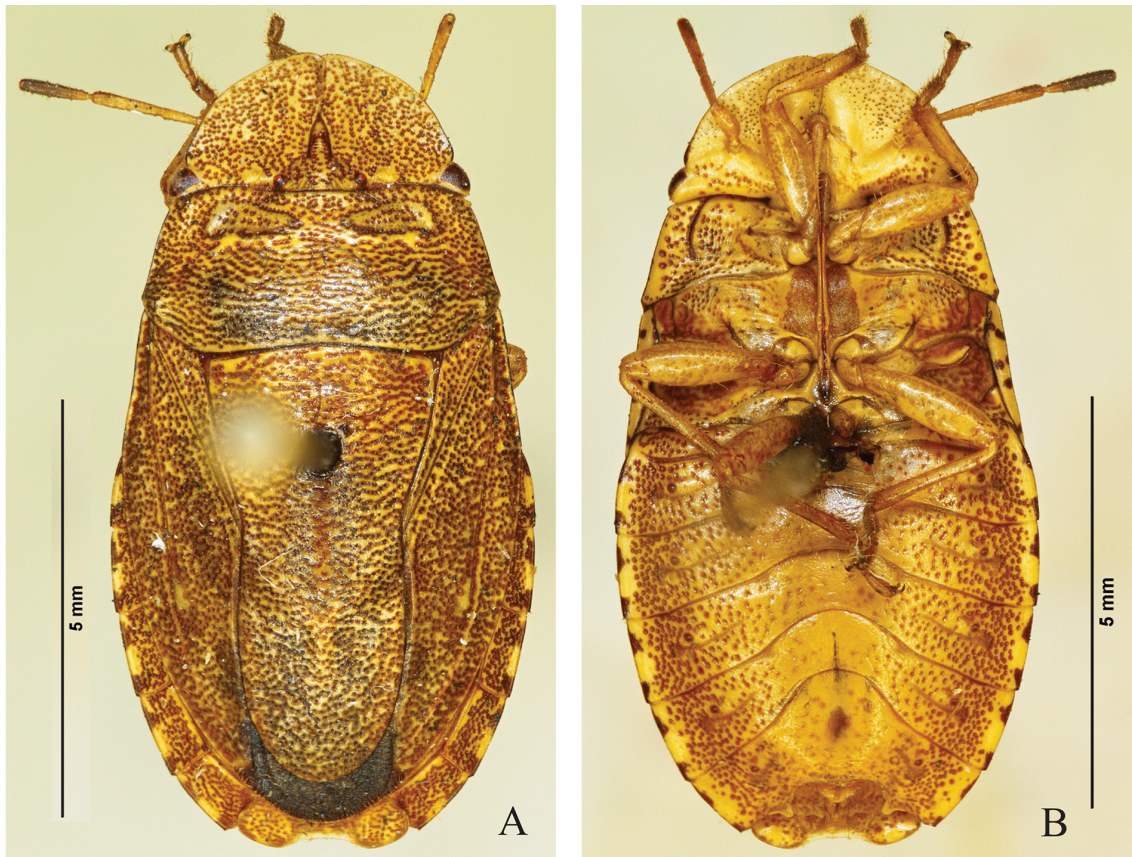

FIGURE 17. *Ischnopelta confusa* Rosso & Campos, sp. n. Female. A, dorsal view; B, ventral view; C, genital plates ventroposterior view (45°); D, internal genitalia. Abbreviations: cl, collar; cs, seminalis capsule; dac, distal annular crest; drd, distal ductus receptaculi; drp, proximal ductus receptaculi; id, internal duct; idp, proximal internal duct; la8, laterotergite VIII; la9, laterotergite IX; md, medium duct; mdp, proximal medium duct; mpr, projection on the lateral third of posterior margin of sternite VII; od, external duct; odp, proximal external duct; pac, proximal annular crest; pi, pars intermedialis; pr, projection; t8, mediotergite VIII; va9, valvulae IX; vf8, valvifer VIII; vf9, valvifer IX; vi, thickening of vaginal intima; X, segment X.

TABLE 5. Measurements (mean, standard deviation, minimum and maximum) and number of *Ischnopelta confusa* Rosso & Campos, sp. n. specimens evaluated (n).

Body structure	Measurements performed	Male		Female	
		n	Measurements (mm)	n	Measurements (mm)
Body	tl	4	8.13±0.50; (7.75–8.82)	4	9.60±0.32; (9.17–9.93)
	mw		4.22±0.19; (4.00–4.45)		5.11±0.15; (4.90–5.21)
Head	hl		1.73±0.10; (1.64–1.88)		1.91±0.10; (1.79–1.97)
	cl		0.52±0.03; (0.49–0.55)		0.60±0.01; (0.59–0.60)
	hw	4	3.26±0.10; (3.14–3.38)	4	3.60±0.06; (3.53–3.64)
	iod		0.90±0.02; (0.89–0.92)		1.01±0.01; (1.00–1.03)
	ied		2.61±0.05; (2.53–2.66)		2.90±0.04; (2.87–2.95)
	pl		1.64±0.07; (1.59–1.74)		1.94±0.03; (1.91–1.97)
Pronotum	haw	4	3.77±0.16; (3.58–3.95)	4	4.33±0.07; (4.26–4.40)
	aaw		3.22±0.10; (3.11–3.35)		3.57±0.06; (3.53–3.64)
	sl		4.56±0.21; (4.36–4.85)		5.53±0.19; (5.35–5.69)
Scutellum	fll		1.80±0.05; (1.74–1.84)		2.14±0.06; (2.09–2.22)
	pfl	4	2.77±0.24; (2.57–3.12)	4	3.39±0.22; (3.13–3.58)
	bsw		2.42±0.08; (2.31–2.49)		2.78±0.14; (2.58–2.90)
	fcw		1.69±0.05; (1.63–1.75)		1.97±0.12; (1.81–2.06)
	I		0.51±0.02; (0.50–0.53)		0.51±0.02; (0.50–0.53)
Antennae	II		0.39±0.02; (0.37–0.40)	3	0.45±0.02; (0.43–0.47)
	III	3	0.81±0.05; (0.78–0.87)		0.81±0.04; (0.78–0.84)
	IV		0.84±0.05; (0.81–0.90)		0.82±0.11; (0.74–0.90)
	V		1.21±0.11; (1.15–1.33)	–	–
	I		0.53±0.00; (0.53–0.53)		0.53±0.09; (0.47–0.59)
Labium	II	2	1.12±0.04; (1.09–1.15)	2	1.27±0.04; (1.24–1.30)
	III		0.47±0.00; (0.47–0.47)		0.54±0.02; (0.53–0.56)
	IV		0.33±0.02; (0.31–0.34)		0.33±0.02; (0.31–0.34)

Legend: tl, total length; mw, maximum width (at the sternite III level); hl, head length; cl, clypeus length; hw, head width; iod, interocellar distance; ied, interocular distance; pl, pronotum length; haw, pronotum width at the level of humeral angles; aaw, pronotum width at the level of anterolateral angles; sl, scutellum length; fll, frenal lobe length; pfl, post-frenal lobe length; bsw, basal scutellum width; fcw, scutellum width at the level of frenal constriction; I, II, III, IV and V, antennal and labium segments length.

Cup-like sclerites externally visible and with subparallel apices (Fig. 16D, cls). Phallus: proximal half of vesica almost as wide as phallosome; distal half of vesica strongly sclerotized, sinuous, and gradually tapering, distal portion posteriorly directed; secondary gonopore circular (Fig. 16J–K).

Female. Membrane of hemelytra not reaching the posterior margin of mediotergite VIII, posterior margin convex; median portion of posterior margin of mediotergite VIII and median portion of posterior margin of sternite VII concave; projections of urosternite VII as described for *I. scutellata* (Fig. 17C, mpr). **Genitalia:** Valvifers VIII as wide as long, posterior margin sinuous; sutural margins subrectilinear and dorsally folded; surface dark yellowish, with brown punctures and setae on the distal portion of sutural rim; longitudinal grooves narrow and shallow on basal surface; a wide and deep groove forming a fold on the distal half of sutural margins (Figs. 5C; 17C, vf8). Valvifers

IX covered by valvifers VIII, lateral margin convex (Fig. 17D, vf9). Laterotergites IX not reaching the posterior margin of mediotergite VIII; lateral margin convex; setae on mid-basal portion of lateral margin and ventral surface (Fig. 17C–D, la9). Thickening of vaginal intima barrel shaped, wider than long; proximal and distal margins concave, the distal one more sclerotized; extensive central area and elliptical areas on the laterals membranous (Fig. 17D, vi). Vesicular area: anterior portion to the collar 1/5 of the posterior portion; median duct anterior to the collar with proximal widening (Fig. 17D, mdp), median duct posterior to the collar with proximal and distal widening (Fig. 17D, md). Distal ductus receptaculi 0.35 times the length of vesicular area posterior to the collar (Fig. 17D, drd, drp). Pars intermedialis conical, broader distally (Fig. 17D, pi); annular crests convergent, the proximal one half the diameter of distal one (Fig. 17D, dac, pac). Capsula seminalis oval, longer than wide and with long laterobasal

projection directed to the pars intermedialis (Fig. 17D, cs, pr).

Measurements: Table 5.

Distribution. Argentina (Formosa, Misiones) (Fig. 6).

Comments. The males of *Ischnopelta confusa* sp. n. (Fig. 16A–B) differ from other species by the the posterolateral angles of pygophore divided in two portions, being the ventral portion easily observed in posterior view (Fig. 16C–E, pla, pr). The females can be identified by the presence of a fold following the distal half of the sutural margin of valvifers VIII (Figs. 5C; 17C, vf8). Although this feature also occurs in *Ischnopelta magna* sp. n. (Figs. 5D; 33C, vf8), *I. confusa* is shorter in size and with the projections of urosternite VII laminate and slightly oblique (Fig. 17C, mpr), while in *I. magna* the projections are thickened and perpendicular to the urosternite surface (Fig. 33C, mpr).

***Ischnopelta coralinae* Rosso & Campos, sp. n.** (Figs. 5I, 18–19)

Etymology. The epithet is in honor to the poet Cora Coralina, codename for Anna Lins dos Guimarães Peixoto Bretas, born in Goiás (Goiás, Brazil). Her poetic work is rich in the daily life of the Brazilian interior, and her first book was published when she was almost 76 years old. She died at 95 years old. The specimens used for the description of the species are mostly from the poet's birth city and nearby locations.

Type locality. BRAZIL, Goiás, Jataí [-17.8872, -51.7182].

Holotype. Male. BRAZIL, Goiás, Jataí, XII.1963, M. Alvarenga. Deposited at Museu de Entomologia Pe. Jesus Santiago Moure, Universidade Federal do Paraná (DZUP), Curitiba (PR), Brazil.

Paratypes. 7 males and 9 females. BRAZIL, Brasília (DF), Brasília (2 km W. Brasília), 1 male and 1 female, 18.XI.1997, T.J. Henry, [-15.7833, -47.9167], (USNM); Goiás, Anápolis, Paraíso, 1 male, 8–14.XI.1962, J. Bechyné Col., [-16,358333, -48,980556], (MZSP); 1 male, J. & B. Bechyné, [-16,358333, -48,980556], (MPEG); Leopoldo de Bulhões, 1 male and 3 females, VII.1935, H.S. Lopes, [-16.6167, -48.7667], (MNRJ); Goiânia, Campinas, 1 male and 1 female, 1935, R. Spitz Coll., [-16.7010, -49.1668], (UFRG); 1 female, XII.1935, Borgmeier & St. Lopes, [-16.7010, -49.1668], (MNRJ); Mineiros, 1 male and 1 female, XI.1960, M. Alvarenga, [-17.5681, -52.5510], (DZUP); Rio Verde, 1 male, XI.1960, M. Alvarenga, [-17.7920, -50.9189], (DZUP); Jataí (Fazenda Aceiro), 1 female, X.1962, Exp. Dep. Zool., [-17.8872, -51.7182], (UFRG); Jataí, 1 female, XII.1963, M. Alvarenga, [-17.8872, -51.7182], (DZUP).

Description. The overall somatic morphology is as described for *I. scutellata*, except for the following features. Labrum inserted anterior to half the distance between the anterior margin of the eyes and the apex of mandibular plates. Antennae dark yellowish, distal portion of segment III light brown; segments ratio: I=II<III<IV<V.

Thorax. Hemelytra: corium as long as scutellum; spot at apex of radial vein usually conspicuous. Pro-, meso- and metapleura dark yellowish and densely punctured. Setae on posterodorsal margin of protibiae as long as the others.

Abdomen. Urosternite VII unarmed.

Male. Apical margin of hemelytral membrane of ; median portion of posterior margin of sternite VII concave; urosternite VII not reaching anteriorly the imaginary line connecting the spiracles of urosternite V. **Genitalia.** Pygophore with dorsal rim concave (Fig. 18C, dr) and ventral rim subrectilinear with shallow median excavation (Fig. 18D, vr). Posterolateral angles 1.6 times longer than the rest of the pygophore, base perpendicular and apex oblique to the frontal plane, convergent from the base (Fig. 18C–E, pla). Setae short on posterior half of ventral and lateral surfaces of pygophore, and on outer surface of posterolateral angles; setae long on ventral and apical margins of posterolateral angles and on ventral rim, except on median excavation. Segment X as wide as long, almost reaching the apex of posterolateral angles; rounded; apical margin flat; basal and apical margins and mid-basal region membranous; dorsal surface covered by setae (Figs. 18C and E, X; 18L–M). Parameres falciform, flat, not reaching the apex of posterolateral angles, subparallel to the frontal plane; proximal portion of outer margin sinuous, distal portion convex, apical margin convex (Fig. 18D and F–H, amp); inner margin sinuous, distal portion strongly excavated and with an apical aculeiform process, convergent and ventrolaterally directed; apical margin slightly convex; ventral surface with an oblique crest (Fig. 18D and G, vcp), covered by setae (Fig. 18F–I). Cup-like sclerites externally visible, apices convergent (Fig. 18D, cls). Phallus: proximal portion of vesica broader, gradually narrowing and slightly bent ventrally, with ventral triangular expansion; distal portion sinuous and bent ventrally; secondary gonopore ventroposterior and beveled (Fig. 18J–K).

Female. Membrane of hemelytra not reaching the posterior margin of mediotergite VIII, posterior margin convex; median portion of posterior margin of mediotergite VIII, urosternite VII, and projections of urosternite VII (Fig. 19C, mpr) as described for *I. scutellata*. **Genitalia.** Valvifers VIII wider than long; posterior margin subrectilinear and slightly oblique to the midline, slightly folded dorsally; sutural margins subrectilinear and folded dorsally; surface dark yellowish with brown punctures, setae on distal portion of sutural margins and on inner portion of posterior margin (Figs. 5I; 19C, vf8). Valvifers IX almost completely covered by valvifers VIII; lateral margin subrectilinear, setae sparse on mid-basal portion of ventral surface (Fig. 19D, vf9). Laterotergites IX reaching the posterior margin of mediotergite VIII; lateral margin subrectilinear; setae on mid-basal portion of lateral margin and ventral surface (Fig. 19C–D, la9). Thickening of vaginal intima sub-hexagonal, slightly wider than long; distal margin slightly concave; distal portions of lateral margins longer than proximal ones and slightly concave, proximal portions subrectilinear; mid-basal trapezoid area membranous (Fig. 19D, vi).

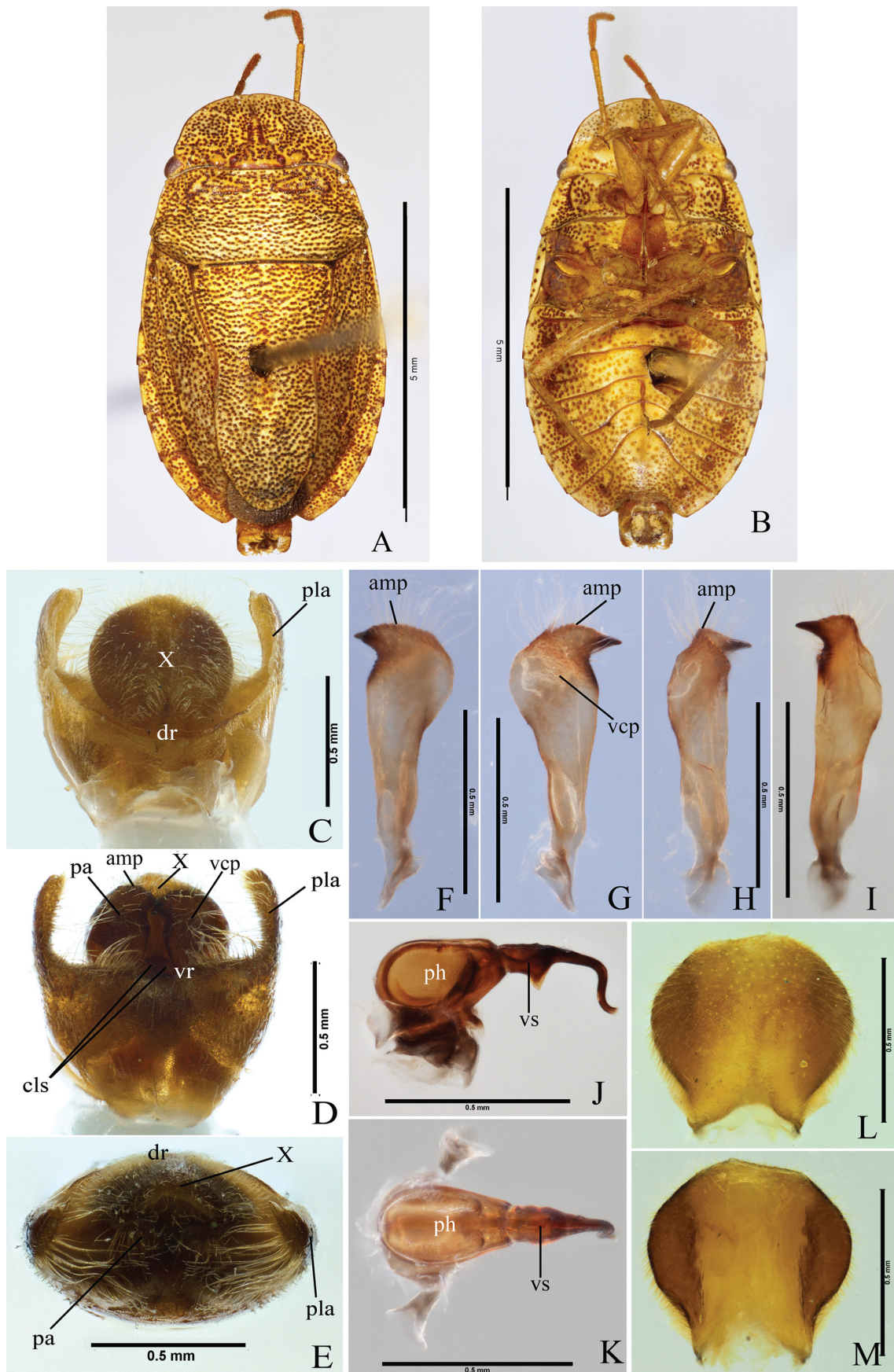

FIGURE 18. *Ischnopelta coralinae* Rosso & Campos, sp. n. Holotype male. A, dorsal view; B, ventral view; C–E, pygophore: dorsal, ventral, and posterior views respectively; F–I, parameters: dorsal, ventral, external and internal lateral views, respectively; J–K, phallus: lateral and dorsal views, respectively; L–M, segment X, dorsal and ventral views, respectively. Abbreviations: amp, apical margin; cls, cup like sclerites; dr, dorsal rim; pa, parameter; ph, phalloteca; pla, posterolateral angle; vcp, ventral crest; vr, ventral rim; vs, vesica; X, segment X.

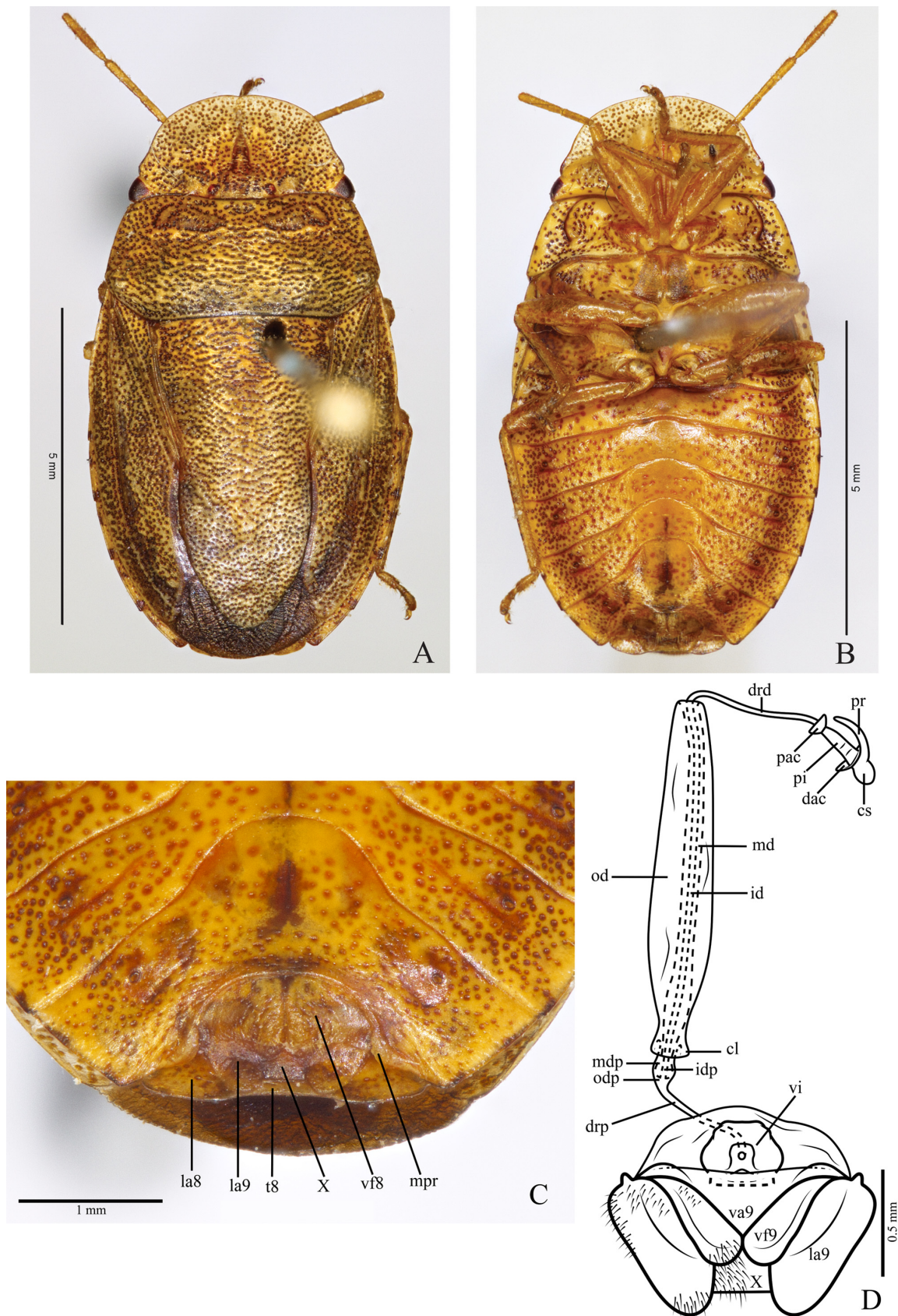

FIGURE 19. *Ischnopelta coralinae* Rosso & Campos, sp. n. Female. A, dorsal view; B, ventral view; C, genital plates ventroposterior view (45°); D, internal genitalia. Abbreviations: cl, collar; cs, seminalis capsule; dac, distal annular crest; drd, distal ductus receptaculi; drp, proximal ductus receptaculi; id, internal duct; idp, proximal internal duct; la8, laterotergite VIII; la9, laterotergite IX; md, medium duct; mdp, proximal medium duct; mpr, projection on the lateral third of posterior margin of sternite VII; od, external duct; odp, proximal external duct; pac, proximal annular crest; pi, pars intermedialis; pr, projection; t8, mediotergite VIII; va9, valvulae IX; vf8, valvifer VIII; vf9, valvifer IX; vi, thickening of vaginal intima; X, segment X.

Vesicular area: anterior portion to the collar 1/10 of the posterior portion; median duct anterior to the collar with slight proximal widening (Fig. 19D, mdp), median duct posterior to the collar with proximal widening (Fig. 19D, md). Distal ductus receptaculi 0.35 times the length of the vesicular area posterior to the collar (Fig. 19D, drd, drp). Pars intermedialis cylindrical (Fig. 19D, pi); annular crests directed to the ductus receptaculi, the proximal slightly larger than half the diameter of the distal one (Fig. 19D, dac, pac). Capsula seminalis globose and with a filiform laterobasal projection directed to the pars intermedialis (Fig. 19D, cs, pr).

Measurements: Table 6.

Distribution. Brazil (Goiás, Brasília—DF) (Fig. 6).

Comments. The species *Ischnopelta coralinae* sp. n. (Figs. 18A–B; 19A–B), *I. cristulata* sp. n. (Figs. 24A–B; 25A–B), *I. impunctata* sp. n. (Figs. 29A–B; 30A–B), *I. luteicornis* (Figs. 31A–B; 32A–B), *I. parvula* sp. n. (Figs. 39A–B; 40A–B), *I. pellucidula* sp. n. (Figs. 41A–D;

42A–B) and *I. ruckesi* sp. n. (Figs. 44A–B; 45A–B), form a group in which all males have the parameres with an aculeiform apical process, convergent and ventrolaterally directed (Figs. 18D–E, pa; 24D–E, pa; 29D–E, pa; 31D–E, pa; 39D–E, pa; 43B–C, pa; 44D–E, pa). The initial separation can be accomplished based on the geographic distribution; however, undoubtful identification is only possible by examining the internal genitalia. The analysis of the posterior margin of valvifers VIII allows a primary separation of the females of this group (Figs. 5F–L; 19C, vf8; 25C, vf8; 30C, vf8; 32C, vf8; 40C, vf8; 43L–M, vf8; 45C, vf8). In *I. coralinae* and *I. pellucidula* the laterotergites IX reach or surpass the posterior margin of mediotergite VIII (Figs. 5I, K; 19C, la9; 43L–M, la9), while in the other species of this group the laterotergites IX do not reach such margin (Figs. 5F–H, J, L; 25C, la9; 30C, la9; 32C, la9; 40C, la9; 45C, la9).

TABLE 6. Measurements (mean, standard deviation, minimum and maximum) and number of *Ischnopelta coralinae* Rosso & Campos, sp. n. specimens evaluated (n).

Body structure	Measurements performed	Male		Female	
		n	Measurements (mm)	n	Measurements (mm)
Body	tl	8	7.37±0.33; (6.90–7.86)	10	8.65±0.25; (8.21–9.11)
	mw		4.23±0.24; (3.91–4.67)		4.90±0.10; (4.77–5.08)
Head	hl		1.57±0.07; (1.48–1.66)		1.71±0.07; (1.60–1.78)
	cl		0.53±0.03; (0.47–0.57)		0.60±0.03; (0.56–0.65)
	hw	10	3.21±0.13; (3.07–3.40)	10	3.50±0.14; (3.31–3.71)
	iod		0.84±0.04; (0.79–0.90)		0.92±0.04; (0.87–0.96)
	ied		2.58±0.11; (2.42–2.75)		2.84±0.13; (2.68–3.01)
Pronotum	pl		1.62±0.08; (1.50–1.73)		1.79±0.04; (1.71–1.84)
	haw	10	3.75±0.19; (3.48–4.05)	10	4.20±0.13; (4.01–4.39)
	aaw		3.16±0.13; (3.00–3.39)		3.51±0.13; (3.33–3.72)
Scutellum	sl		4.12±0.27; (3.70–4.54)		4.74±0.18; (4.52–5.11)
	fl		1.68±0.11; (1.52–1.89)		1.92±0.08; (1.79–2.05)
	pfl	10	2.44±0.21; (2.10–2.67)	10	2.82±0.16; (2.55–3.05)
	bsw		2.45±0.12; (2.29–2.70)		2.76±0.11; (2.60–2.96)
	fcw		1.68±0.10; (1.53–1.84)		1.98±0.11; (1.82–2.19)
Antennae	I		0.46±0.03; (0.43–0.50)		0.53±0.00; (0.53–0.53)
	II		0.50±0.02; (0.47–0.54)		0.51±0.02; (0.50–0.53)
	III	6	0.79±0.07; (0.71–0.90)	2	0.84±0.09; (0.78–0.90)
	IV		0.95±0.07; (0.84–1.01)		0.96±0.00; (0.96–0.96)
	V	5	1.26±0.09; (1.18–1.37)		1.22±0.02; (1.21–1.24)
Labium	I		0.62±0.02; (0.61–0.65)		0.64±0.01; (0.62–0.65)
	II		1.26±0.07; (1.19–1.33)		1.38±0.04; (1.33–1.43)
	III	3	0.58±0.04; (0.54–0.61)	5	0.59±0.02; (0.56–0.62)
	IV		0.40±0.04; (0.36–0.43)		0.42±0.02; (0.40–0.43)

Legend: tl, total length; mw, maximum width (at the sternite III level); hl, head length; cl, clypeus length; hw, head width; iod, interocellar distance; ied, interocular distance; pl, pronotum length; haw, pronotum width at the level of humeral angles; aaw, pronotum width at the level of anterolateral angles; sl, scutellum length; fl, frenal lobe length; pfl, post-frenal lobe length; bsw, basal scutellum width; fcw, scutellum width at the level of frenal constriction; I, II, III, IV and V, antennal and labium segments length.

***Ischnopelta cordiformis* Rosso & Campos, sp. n.**
(Figs. 5Q, 20–21)

Etymology. The epithet refers to the shape of the male segment X. Latin: *cordis* = heart + *formis* = form, shape.

Type locality. BRAZIL, *Mato Grosso*, Santa Terezinha [-10.646111, -50.613056].

Holotype. Male. BRAZIL, *Mato Grosso*, Santa Terezinha (mouth of Rio Tapirapé), 26.XII.1962, B. Malkin. Deposited at Museu Paraense Emílio Goeldi (MPEG), Belém (PA), Brazil.

Paratypes. 1 male and 2 females. BRAZIL, *Mato Grosso*, Santa Terezinha (mouth of Rio Tapirapé), 1 female, 1.X.1963, [-10.646111, -50.613056], (CAS); Santa Terezinha (Porto Velho), 1 female, 15.XI–15.XII.1962, R. Pinheiros, [-10.7728, -51.0056], (DZUP); São Félix do Araguaia, 1 male, VI.1961, M. Alvarenga, [-11.6169, -50.6689], (CAS).

Description. The overall somatic morphology is

as described for *I. scutellata*, except for the following features. Male and female respectively 2 and 2.1 times longer than wide. Head. Labium reaching the metacoxae. Labrum inserted anterior to half the distance between the anterior margin of the eyes and the apex of mandibular plates. Antennae segments I to III dark yellowish with brown blotches and punctures, segments IV and V brown; segments ratio: I>II<III<IV<V.

Thorax. Hemelytra: corium as long as scutellum; conspicuous spot at apex of radial vein.

Male. Apical margin of membrane of hemelytra convex; median portion of posterior margin of urosternite VII subrectilinear; urosternite VII reaching anteriorly the imaginary line connecting the spiracles of sternite V. **Genitalia.** Pygophore with dorsal rim concave (Fig. 20C, dr) and ventral rim slightly concave (Fig. 20D, vr). Posterolateral angles 0.5 times shorter than the rest of the pygophore, perpendicular to the frontal plane and divergent from the base (Fig. 20C–E, pla). Setae short and sparse on

TABLE 7. Measurements (mean, standard deviation, minimum and maximum) and number of *Ischnopelta cordiformis* Rosso & Campos, sp. n. specimens evaluated (n).

Body structure	Measurements performed	Male		Female	
		n	Measurements (mm)	n	Measurements (mm)
Body	tl	2	6.22±0.31; (6.00–6.44)	2	7.32±0.23; (7.15–7.48)
	mw		3.16±0.19; (3.03–3.30)		3.49±0.12; (3.41–3.58)
Head	hl		1.56±0.00; (1.56–1.56)		1.68±0.01; (1.67–1.68)
	cl		0.48±0.00; (0.48–0.48)		0.54±0.00; (0.54–0.54)
	hw	2	3.00±0.17; (2.88–3.12)	2	3.33±0.04; (3.30–3.36)
	iod		0.83±0.02; (0.81–0.84)		0.89±0.01; (0.88–0.90)
	ied		2.37±0.13; (2.28–2.46)		2.69±0.02; (2.67–2.70)
Pronotum	pl		1.29±0.04; (1.27–1.32)		1.43±0.08; (1.38–1.49)
	haw	2	2.89±0.19; (2.75–3.03)	2	3.27±0.04; (3.25–3.30)
	aaw		2.61±0.12; (2.53–2.70)		2.86±0.00; (2.86–2.86)
Scutellum	sl		3.33±0.19; (3.19–3.47)		3.85±0.00; (3.85–3.85)
	fl		1.35±0.04; (1.32–1.38)		1.60±0.00; (1.60–1.60)
	pfl	2	1.98±0.16; (1.87–2.09)	2	2.26±0.00; (2.26–2.26)
	bsw		1.90±0.19; (1.76–2.04)		2.20±0.08; (2.15–2.26)
	fcw		1.29±0.12; (1.21–1.38)		1.54±0.00; (1.54–1.54)
Antennae	I	2	0.40±0.04; (0.38–0.43)	2	0.44±0.02; (0.43–0.45)
	II		0.33		0.38
	III		0.63	1	0.68
	IV	1	0.73		0.78
	V		0.95	0	–
Labium	I	2	0.54±0.02; (0.53–0.55)		0.60±0.04; (0.58–0.63)
	II		1.21±0.05; (1.18–1.25)	2	1.31±0.02; (1.30–1.33)
	III		0.55		0.56±0.02; (0.55–0.58)
	IV	1	0.28		0.30±0.00; (0.30–0.30)

Legend: tl, total length; mw, maximum width (at the sternite III level); hl, head length; cl, clypeus length; hw, head width; iod, interocellar distance; ied, interocular distance; pl, pronotum length; haw, pronotum width at the level of humeral angles; aaw, pronotum width at the level of anterolateral angles; sl, scutellum length; fl, frenal lobe length; pfl, post-frenal lobe length; bsw, basal scutellum width; fcw, scutellum width at the level of frenal constriction; I, II, III, IV and V, antennal and labium segments length.

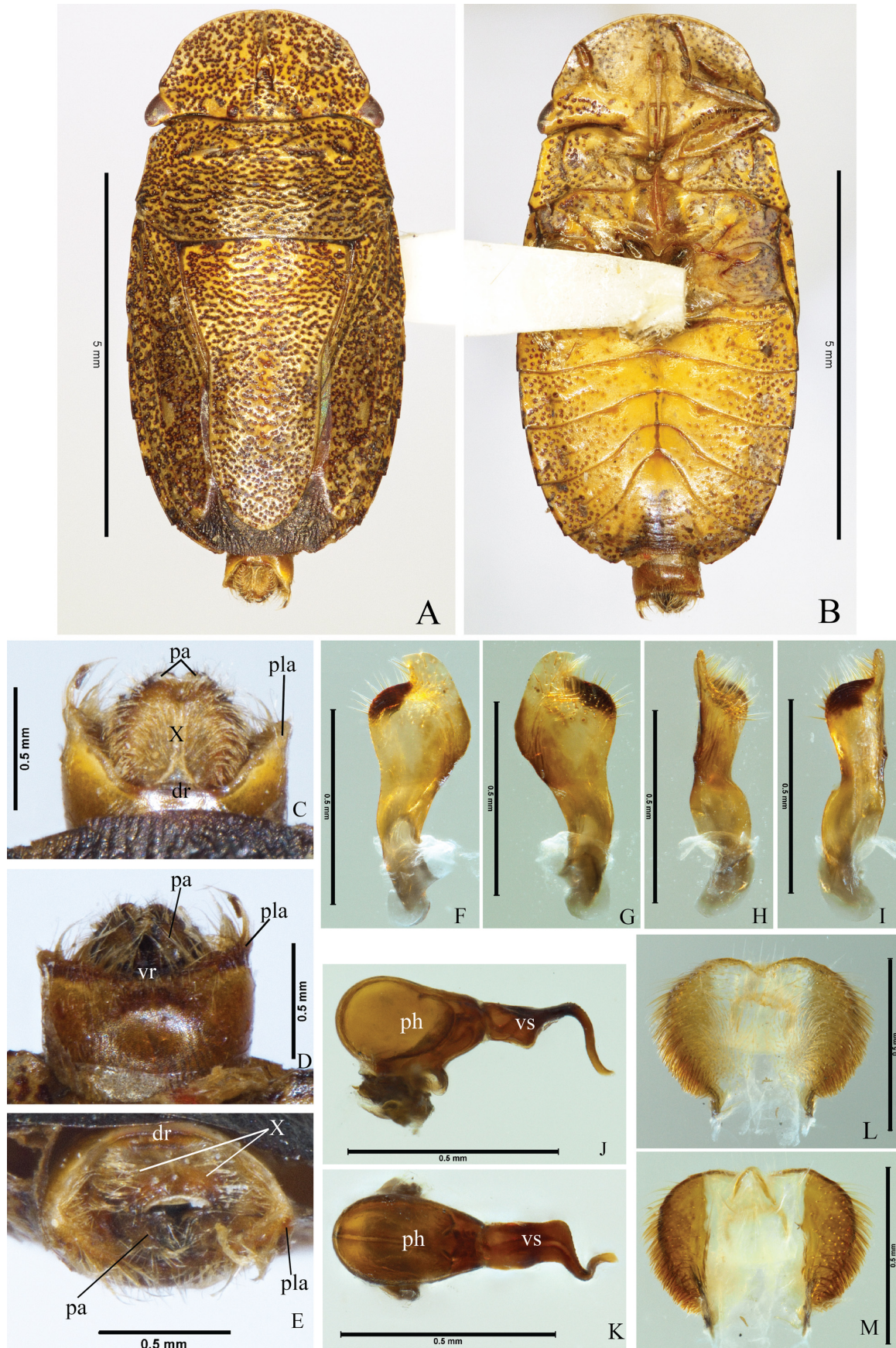

FIGURE 20. *Ischnopelta cordiformis* Rosso & Campos, sp. n. Holotype male. A, dorsal view; B, ventral view, C–E, pygophore: dorsal, ventral and posterior views respectively; F–I, parameters: dorsal, ventral, external and internal lateral views, respectively; J–K, phallus: lateral and dorsal views, respectively; L–M, segment X, dorsal and ventral views, respectively. Abbreviations: dr, dorsal rim; pa, parameter; ph, phalloteca; pla, posterolateral angle; vr, ventral rim; vs, vesica; X, segment X.

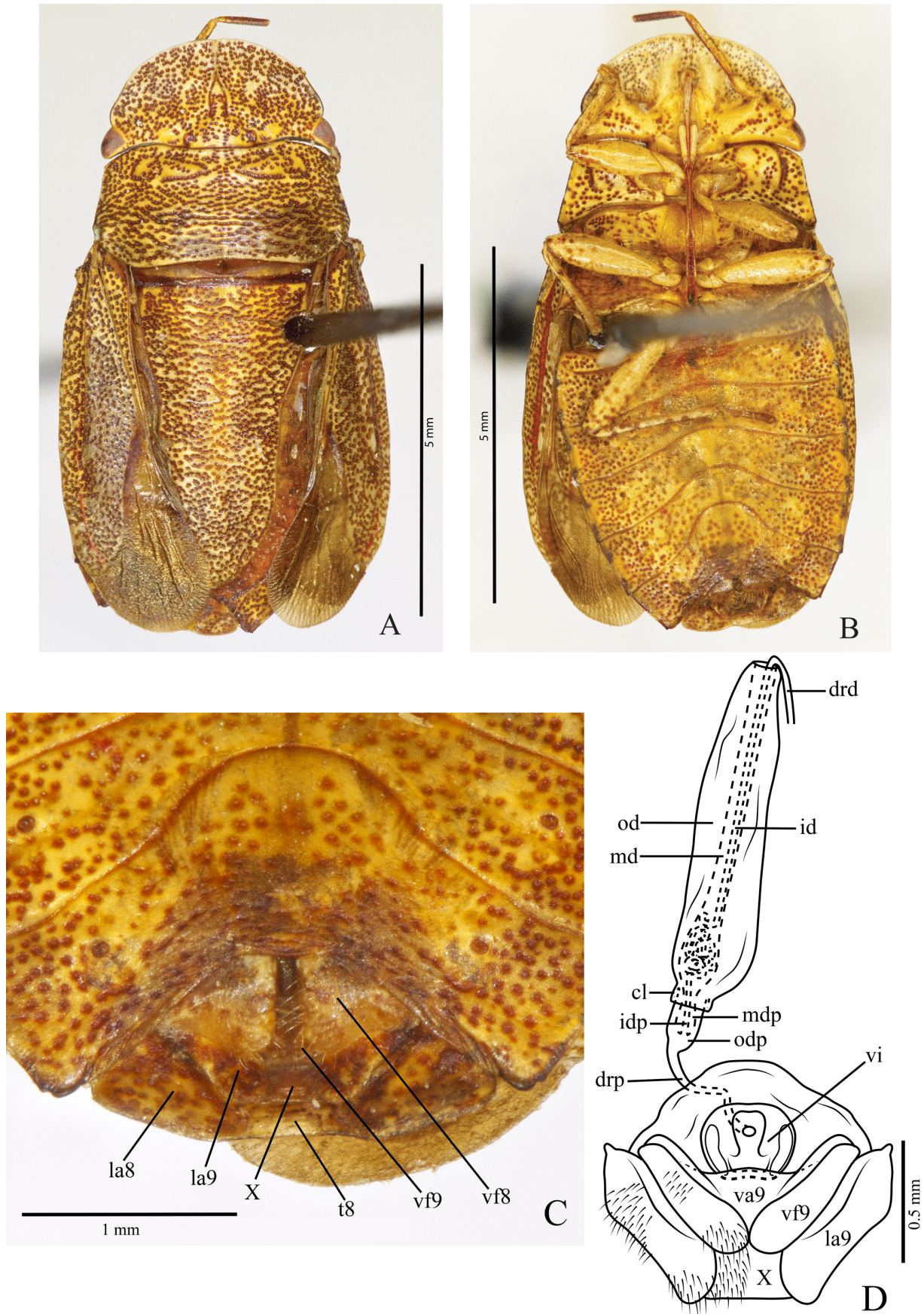

FIGURE 21. *Ischnopelta cordiformis* Rosso & Campos, sp. n. Female. A, dorsal view; B, ventral view; C, genital plates ventroposterior view (45°); D, internal genitalia. Abbreviations: cl, collar; drd, distal ductus receptaculi; drp, proximal ductus receptaculi; id, internal duct; idp, proximal internal duct; la8, laterotergite VIII; la9, laterotergite IX; md, medium duct; mdp, proximal medium duct; od, external duct; odp, proximal external duct; t8, mediotergite VIII; va9, valvulae IX; vf8, valvifer VIII; vf9, valvifer IX; vi, thickening of vaginal intima; X, segment X.

posterior half of ventral and lateral surfaces of pygophore; setae long and dense on ventral rim and on ventral and apical margins of posterolateral angles. Segment X wider than long, surpassing the apex of posterolateral angles, but not the parameres; cordiform; apical margin sclerotized and emarginated; lateral margins sclerotized and covered by long setae, mid-longitudinal region membranous and with short and sparse setae (Figs. 20C and E, X; 20L–M). Parameres claviform, head wide, oblique to the frontal plane; outer margin sinuous, slightly concave on proximal half and strongly convex on distal half; inner margin sinuous, distal portion strongly sclerotized, sinuous; apical process convergent; setae covering the ventral distal half of the head, and the sclerotized area (Figs. 20D, pa; 20F–I). Cup-like sclerites externally visible, apices rounded and subparallel. Phallus: proximal half of vesica broader laterally, dorsally flattened and ventrally expanded; distal half sinuous; secondary gonopore ventral and beveled (Fig. 20J–K).

Female. Membrane of hemelytra not reaching the posterior margin of mediotergite VIII, posterior margin convex; median portion of posterior margin of both mediotergite VIII and urosternite VII subrectilinear; projections on the lateral 1/3 of posterior margin of sternite VII undeveloped (Fig. 21C). **Genitalia.** Valvifers VIII wider than long; posterior margin sinuous, moderately oblique to the median line, portion on the sutural margins narrow and acutely rounded, lateral portion slightly concave; sutural margins subrectilinear and folded dorsally; surface convex, dark yellowish with brown punctures and setae on sutural margins and sutural angles (Figs. 5Q; 21C, vf8). Valvifers IX almost completely covered by valvifers VIII; lateral margin subrectilinear; setae on mid-basal portion of ventral surface (Fig. 21C–D, vf9). Laterotergites IX not reaching the posterior margin of mediotergite VIII; lateral margin sinuous; setae on median portion of lateral margin and mid-basal portion of ventral surface (Fig. 21C–D, la9). Thickening of vaginal intima subcircular, slightly wider than long; distal portion more sclerotized; apical margin slightly concave, ventral cone membranous, oval (Fig. 21D, vi). Vesicular area: anterior portion to the collar 1/8 of the posterior portion; median duct anterior to the collar with slight proximal widening (Fig. 21D, mdp); median duct posterior to the collar with both proximal and distal widening (Fig. 21D, md); inner duct coiled in the proximal widening of the median duct (Fig. 21D, id). Pars intermedialis and capsula seminalis not examined.

Measurements: Table 7.

Distribution. Brazil (Mato Grosso) (Fig. 7).

Comments. Although the posterior margin of valvifers VIII of *Ischnopelta cordiformis* sp. n. is similar to *I. montana* sp. n., in *I. cordiformis* the sutural portion is more angular and the median portion is subrectilinear (Figs. 5Q; 21C, vf8), while in *I. montana* the sutural portion is strongly convex, and the lateral portion is concave (Figs. 5R; 37C, vf8). Besides that, the lateral abdominal margins in *I. montana* are delineate by an unpunctured narrow band where two subtriangular dark-brown spots are observed on the laterals of the urosternites

(Fig. 37B), while in *I. cordiformis* the punctures extend close to the abdominal margins, leaving only small unpunctured areas, and the lateral spots are narrower and irregular, sometimes elongated (Fig. 21B). Lastly, females of *I. cordiformis* do not present sclerotized rims on the lateral 1/3 of posterior margin of urosternite VII. The undeveloped posterolateral angles, and the cordiform segment X with broad membranous area in *I. cordiformis* (Figs. 20C–D, pla; 20L–M) allows to easily distinguish it from *I. montana*, whose posterolateral angles are more developed and subtriangular, and the segment X is rounded and strongly sclerotized (Figs. 36C–D, pla; 36L–M).

***Ischnopelta crassula* Rosso & Campos, sp. n.** (Figs. 5P, 22–23)

Etymology. Epithet proposed by Dr. H. Ruckes as registered in the manuscripts found with the specimens used in the study. He considered that this species has thicker and more irregular punctures, from which the epithet is inferred. Latin *crassus* = thick + *ula* = diminutive.

Type locality. PARAGUAY, *Central*, San Bernardino [-25.2667, -57.3167].

Holotype. Male. PARAGUAY, *Central*, San Bernardino (2 km S. San Bernardino), 6.II.1968, L. & C. W. O'Brien. Deposited at the National Museum of Natural History (USNM), Washington D.C., USA.

Paratypes. 7 males and 13 females. BRAZIL, *Mato Grosso do Sul*, Corumbá, 1 male and 1 female, 16.X.1956, C. R. Gonçalves, [-19.0167, -57.65], (MNRJ, Coleção Campos Seabra); PARAGUAY, *Concepcion*, Vallemi, 1 male and 2 females, 4.II.1976, Delloach, [-22.1333, -57.9667], (USNM); *Central*, Asunción, 2 males and 3 females, B. Podtiaguin. [-25.2939, -57.6111], (AMNH); San Bernardino, 2 females, 14.I.1939, Dernier Coll., [-25.2667, -57.3167], (MLPA); 1 male and 1 female, Fiebrig, [-25.2667, -57.3167], (UFRG); San Bernadino (Ypacaraí lake), 1 female, 11.X.1968, L. & C.W. O'Brien, [-25.2667, -57.3167], (J.E. Eger, Private Collection); Areguá, 1 male and 1 female, 7.V.2006, C. Aguilar, [-25.3125, -57.3847], (J.E. Eger, Private Collection); Lambaré, 1 female, 9.X.1989, G. Arriagada, [-25.3125, -57.3847], (J.E. Eger, Private Collection); ARGENTINA, *Misiones*, 1 male and 1 female, [-27.3671, -55.8961], (MLPA).

Description. The overall somatic morphology is as described for *I. scutellata*, except for the following features. Head. Labrum inserted anterior to half the distance between the anterior margin of the eyes and the apex of mandibular plates. Antennae dark yellowish, segment III brownish; antennal segment ratio: I>II<III<IV<V.

Thorax. Scutellum reaching the apical angles of urosternite VI. Hemelytra: conspicuous spot at apex of radial vein. Evaporatorium not reaching the lateral margin of mesopleura. Setae on posterodorsal margin of protibiae as long as the others.

Abdomen. Some specimens present extensive reddish blotches on the median region of urosternites.

Male. Apical margin of membrane of hemelytra convex. Median portion of posterior margin of urosternite

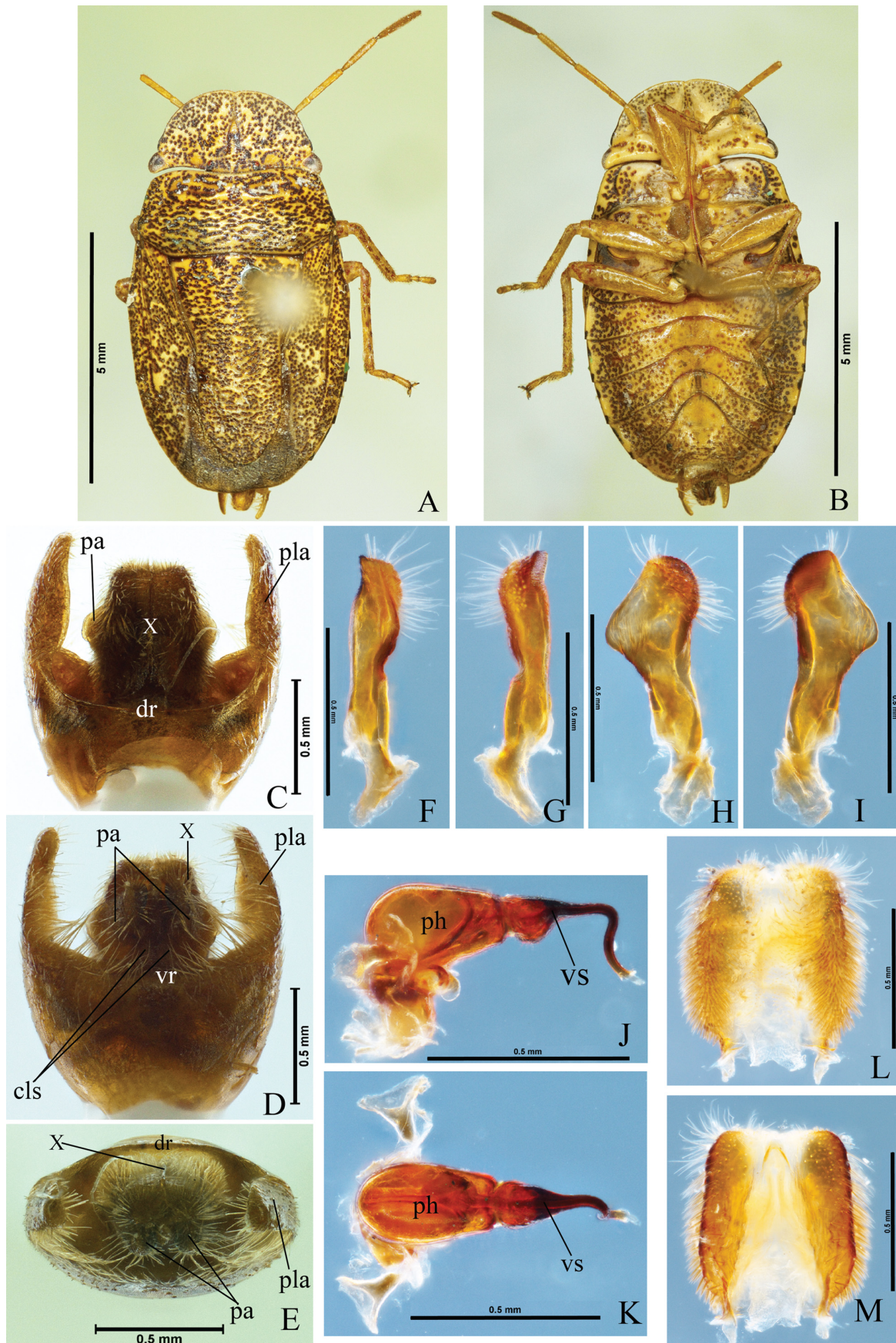

FIGURE 22. *Ischnopelta crassula* Rosso & Campos, sp. n. Holotype male. A, dorsal view; B, ventral view; C–E, pygophore: dorsal, ventral, and posterior views respectively; F–I, parameters: dorsal, ventral, external and internal lateral views, respectively; J–K, phallus: lateral and dorsal views, respectively; L–M, segment X, dorsal and ventral views, respectively. Abbreviations: cls, cup like sclerites; dr, dorsal rim; pa, parameter; ph, phallotecca; pla, posterolateral angle; vr, ventral rim; vs, vesica; X, segment X.

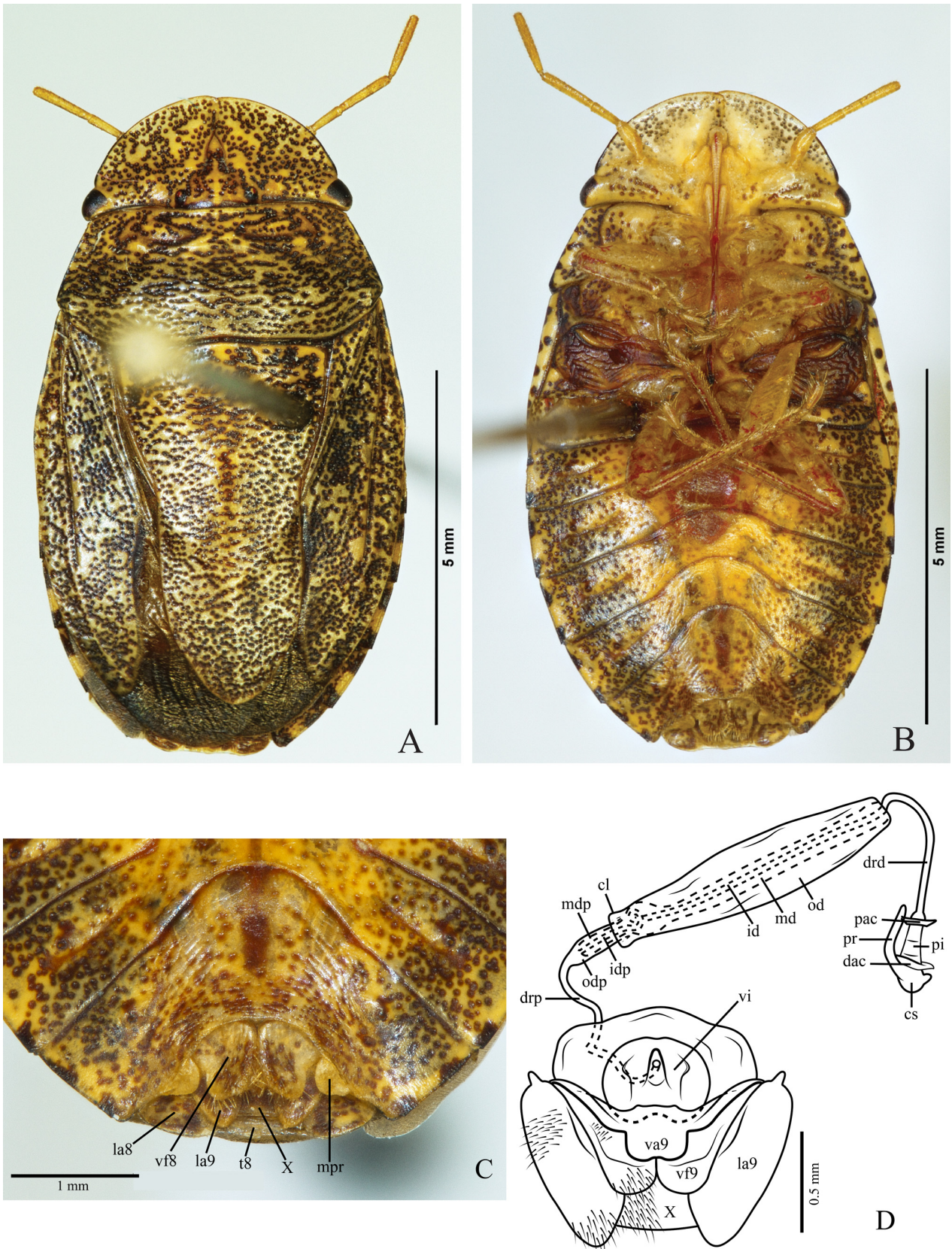

FIGURE 23. *Ischnopelta crassula* Rosso & Campos, sp. n. Female. A, dorsal view; B, ventral view; C, genital plates ventroposterior view (45°); D, internal genitalia. Abbreviations: cl, collar; cs, seminalis capsule; dac, distal annular crest; drd, distal ductus receptaculi; drp, proximal ductus receptaculi; id, internal duct; idp, proximal internal duct; la8, laterotergite VIII; la9, laterotergite IX; md, medium duct; mdp, proximal medium duct; mpr, projection on the lateral third of posterior margin of sternite VII; od, external duct; odp, proximal external duct; pac, proximal annular crest; pi, pars intermedialis; pr, projection; t8, mediotergite VIII; va9, valvulae IX; vf8, valvifer VIII; vf9, valvifer IX; vi, thickening of vaginal intima; X, segment X.

VII subrectilinear; urosternite VII not reaching anteriorly the imaginary line connecting the spiracles of sternite V. **Genitalia.** Pygophore with dorsal and ventral rim concave (Figs. 22C, dr; 22D, vr). Posterolateral angles 1.8 times longer than the rest of the pygophore, perpendicular to the frontal plane and convergent from the base, dorsal margin folded to the interior of pygophore (Fig. 22C–E, pla). Setae short and sparse on posterior half of ventral and lateral surface of the pygophore, and on outer surface of posterolateral angles; setae long on ventral rim, and apex and ventral margin of posterolateral angles. Segment X longer than wide, surpassing the apex of parameres, but not reaching the apex of posterolateral angles; subrectangular, and strongly emarginated apically; lateral margins sclerotized and covered by long setae; mid-longitudinal area membranous and with short and sparse setae (Figs. 22C; 22L–M, X). Parameres claviform, perpendicular to the frontal plane; outer and inner surfaces sinuous, distal portion of inner surface slightly

concave, with differentiated texture formed by transversal lines; acute and convergent apical process; ventral surface sinuous; dorsal surface narrow, distal half strongly convex distally; setae covering apical portions of ventral and outer surfaces, and posterior margin (Fig. 22F–I). Cup-like sclerites visible externally and with rounded and subparallel apices (Fig. 22D, cls). Phallus: proximal half of vesica as wide as distal margin of phallosome, dorsally flat and ventrally convex, gradually narrowing until curving ventrally; distal half sinuous and curved ventrally; secondary gonopore beveled (Fig. 22J–K).

Female. Hemelytral membrane not reaching the posterior margin of mediotergite VIII, posterior margin convex; median portion of posterior margin of mediotergite VIII subrectilinear; median portion of posterior margin of urosternite VII concave; projections of urosternite VII (Fig. 23C, mpr) as described for *I. scutellata*. **Genitalia.** Valvifers VIII wider than long; posterior margin strongly sinuous, sutural margin slightly convex and oblique

TABLE 8. Measurements (mean, standard deviation, minimum and maximum) and number of *Ischnopelta crassula* Rosso & Campos, sp. n. specimens evaluated (n).

Body structure	Measurements performed	Male		Female	
		n	Measurements (mm)	n	Measurements (mm)
Body	tl	8	8.07±0.37; (7.34–8.47)	13	9.45±0.34; (8.91–9.93)
	mw		4.55±0.17; (4.21–4.78)		5.28±0.18; (4.93–5.65)
Head	hl		1.70±0.08; (1.54–1.79)		1.84±0.07; (1.75–1.94)
	cl		0.61±0.02; (0.57–0.65)		0.62±0.04; (0.56–0.69)
	hw	8	3.57±0.17; (3.28–3.77)	13	3.87±0.15; (3.65–4.13)
	iod		0.98±0.04; (0.90–1.02)		1.05±0.04; (0.98–1.14)
	ied		2.87±0.16; (2.59–3.07)		3.13±0.12; (2.95–3.33)
	pl		1.75±0.10; (1.61–1.87)		1.98±0.09; (1.86–2.15)
Pronotum	haw	8	4.15±0.17; (3.87–4.34)	13	4.68±0.20; (4.37–5.03)
	aaw		3.51±0.14; (3.25–3.72)		3.81±0.15; (3.61–4.13)
	sl		4.45±0.22; (4.05–4.80)		5.11±0.25; (4.62–5.48)
Scutellum	fll		1.86±0.07; (1.77–1.98)		2.14±0.11; (1.94–2.35)
	pfl	8	2.60±0.17; (2.28–2.82)	13	2.97±0.18; (2.53–3.28)
	bsw		2.72±0.13; (2.51–2.87)		3.07±0.13; (2.86–3.31)
	fcw		1.78±0.08; (1.63–1.87)		2.09±0.11; (1.97–2.28)
Antennae	I		0.49±0.03; (0.47–0.53)		0.51±0.02; (0.47–0.53)
	II	8	0.44±0.02; (0.40–0.47)	7	0.47±0.04; (0.40–0.53)
	III		0.86±0.03; (0.84–0.90)		0.90±0.04; (0.84–0.96)
	IV	7	0.93±0.01; (0.90–0.93)		0.96±0.03; (0.93–0.99)
	V		1.13±0.04; (1.09–1.18)	3	1.12±0.03; (1.09–1.15)
Labium	I		0.61±0.02; (0.59–0.65)		0.69±0.02; (0.68–0.71)
	II	6	1.38±0.04; (1.30–1.43)	9	1.43±0.02; (1.40–1.46)
	III		0.53±0.01; (0.53–0.56)		0.57±0.03; (0.53–0.62)
	IV		0.36±0.03; (0.34–0.40)		0.43±0.06; (0.37–0.59)

Legend: tl, total length; mw, maximum width (at the sternite III level); hl, head length; cl, clypeus length; hw, head width; iod, interocellar distance; ied, interocular distance; pl, pronotum length; haw, pronotum width at the level of humeral angles; aaw, pronotum width at the level of anterolateral angles; sl, scutellum length; fll, frenal lobe length; pfl, post-frenal lobe length; bsw, basal scutellum width; fcw, scutellum width at the level of frenal constriction; I, II, III, IV and V, antennal and labium segments length.

in relation to the median line, lateral portion sinuous, partially subparallel to the sutural rim; sutural margins subrectilinear and dorsally folded; surface dark yellowish with brown punctures; setae on sutural margins and on median half of posterior margin; longitudinal grooves narrow and shallow (Figs. 5P; 23C, vf8). Valvifers IX covered by valvifers VIII; lateral margin subrectilinear; setae on mid-basal portion of ventral surface (Fig. 23D, vf9). Laterotergites IX not reaching the posterior margin of mediotergite VIII; lateral margin convex; setae on median portion of lateral margin and mid-basal portion of ventral surface (Fig. 23C–D, la9). Thickening of vaginal intima subcircular, wider than long; proximal margin sinuous and wider than the distal one, distal margin weakly emarginated; median area with small membranous subtriangular cone, and sinuous longitudinal ventral crests (Fig. 23D, vi). Vesicular area: anterior portion to the collar with slight proximal widening (Fig. 23D, mdp), median duct posterior to the collar with proximal and distal widening (Fig. 23D, md), inner duct coiled in the proximal widening (Fig. 23D, id). Distal ductus receptaculi 0.5 the length of the vesicular area posterior to the collar (Fig. 23D, drd, drp). Pars intermedialis broader distally (Fig. 23D, pi); annular crests perpendicular to the pars intermedialis, the proximal slightly smaller than the distal one (Fig. 23D, dac, pac). Capsula seminalis globose, with a long and sinuous laterobasal filiform projection directed to the pars intermedialis, and a minute lateral projection (Fig. 23D, cs, pr).

Measurements: Table 8.

Distribution. Brazil (Mato Grosso do Sul), Paraguay (Concepcion, Central, Itapuá), Argentina (Misiones) (Fig. 7).

Comments. See observations in *I. alalonga* sp.n..

***Ischnopelta cristulata* Rosso & Campos, sp. n.** (Figs. 5H, 24–25)

Etimology. The epithet refers to the presence of a transverse small crest on the ventral surface of parameres. Latin: *cristula* = small crest.

Type locality. BRAZIL, *Mato Grosso*, Rondonópolis [-16.4679, -54.6414].

Holotype. Male. BRAZIL, *Mato Grosso*, Rondonópolis, XI.1963, M. Alvarenga. Deposited at Museu de Entomologia Pe. Jesus Santiago Moure, Universidade Federal do Paraná (DZUP), Curitiba (PR), Brazil.

Paratypes. 4 males and 14 females. BRAZIL, *Rondonia*, Vilhena, 1 female, 21.II.1961, J. & B. Bechyně, [-12.7363, -60.1309], (MPEG); *Mato Grosso*, Campo Novo do Parecis, Utiariti (Papagaio river), 2 males and 6 females, 7.VIII.1961, K. Lenko, [-13.0215, -58.2870], (UFRG), 1 female, 22–31.X.1966, K. Lenko, [-13.0215, -58.2870], (UFRG); Rondonópolis, 2 males and 2 females, XI.1963, M. Alvarenga, [-16.4679, -54.6414], (DZUP); *Mato Grosso do Sul*, Campo Grande, Indubrasil (N. O. B zone), 4 females, 17.X.1938, Exp. Instituto Oswaldo Cruz, [-20.4775, -54.762222], (FIOC).

Description. The overall somatic morphology is as described for *I. scutellata*, except for the following features. Head. Labrum inserted anterior to half the distance between the anterior margin of the eyes and the apex of mandibular plates. Antennae dark yellowish, segments IV and V slightly darker than others, some with minute punctures on segments II and III; segments ratio: I<II<III<IV<V.

Thorax. Hemelytra: corium as long as scutellum; conspicuous spot at apex of radial vein. Membrane with veins ramified. Setae on posterodorsal margin of protibiae as long as the others.

Abdomen. Dark spots at the lateral of urosternites subequal, both narrow; urosternite VII unarmed.

Male. Apical margin of membrane of hemelytra convex. Median portion of posterior margin of urosternite VII concave; urosternite VII not reaching anteriorly the imaginary line connecting the spiracles of urosternite V.

Genitalia. Pygophore with dorsal rim concave and median portion subrectilinear (Fig. 24C, dr); ventral rim slightly concave (Fig. 24D, vr). Posterolateral angles 1.24 times longer than the rest of the pygophore, base perpendicular and apex oblique to the frontal plane, convergent from the base (Fig. 24C–E, pla). Short setae on distal half of ventral and lateral surface of pygophore, and on outer and inner surfaces of posterolateral angles; long setae on ventral rim, except on median portion, and on ventral and apical margins of posterolateral angles. Segment X slightly wider than long, not reaching the apex of posterolateral angles and parameres; rounded; apical margin flat and membranous, lateral margins convex, more sclerotized and covered by long setae; median portion membranous, covered by short setae (Figs. 24C–E, X; 24L–M). Parameres falciform, flat, surpassing the apical margin of segment X, and reaching the apex of posterolateral angles; subparallel to the frontal plane; proximal portion of the outer margin slightly concave, apical portion strongly convex; inner margin sinuous, distal portion strongly excavated and with an apical aculeiform process, convergent and ventrolaterally directed; apical margin convex; ventral surface with a transverse crest delimiting the apical region (Fig. 24G, vcp); setae covering the crest and the area posterior to it (Figs. 24D, pa; 24F–I). Cup-like sclerites externally visible and with convergent apices (Fig. 24D, cls). Phallus: proximal 2/3 of vesica dorsally convex and ventroposteriorly directed, base as wide as apical margin of phallosome, gradually narrowing posteriorly, expanded ventrally; distal 1/3 sinuous; secondary gonopore ventroposterior and beveled (Fig. 24J–K).

Female. Membrane of hemelytra not reaching the posterior margin of mediotergite VIII, posterior margin convex; median portion of subrectilinear; median portion of posterior margin of urosternite VII convex; posterior margin of mediotergite VIII and projections of urosternite VII (Fig. 25C, mpr) as described for *I. scutellata*.

Genitalia. Valvifers VIII wider than long; posterior margin subrectilinear and slightly oblique to the median line, sutural margins subrectilinear and folded dorsally; surface dark yellowish with punctures and brown blotches;

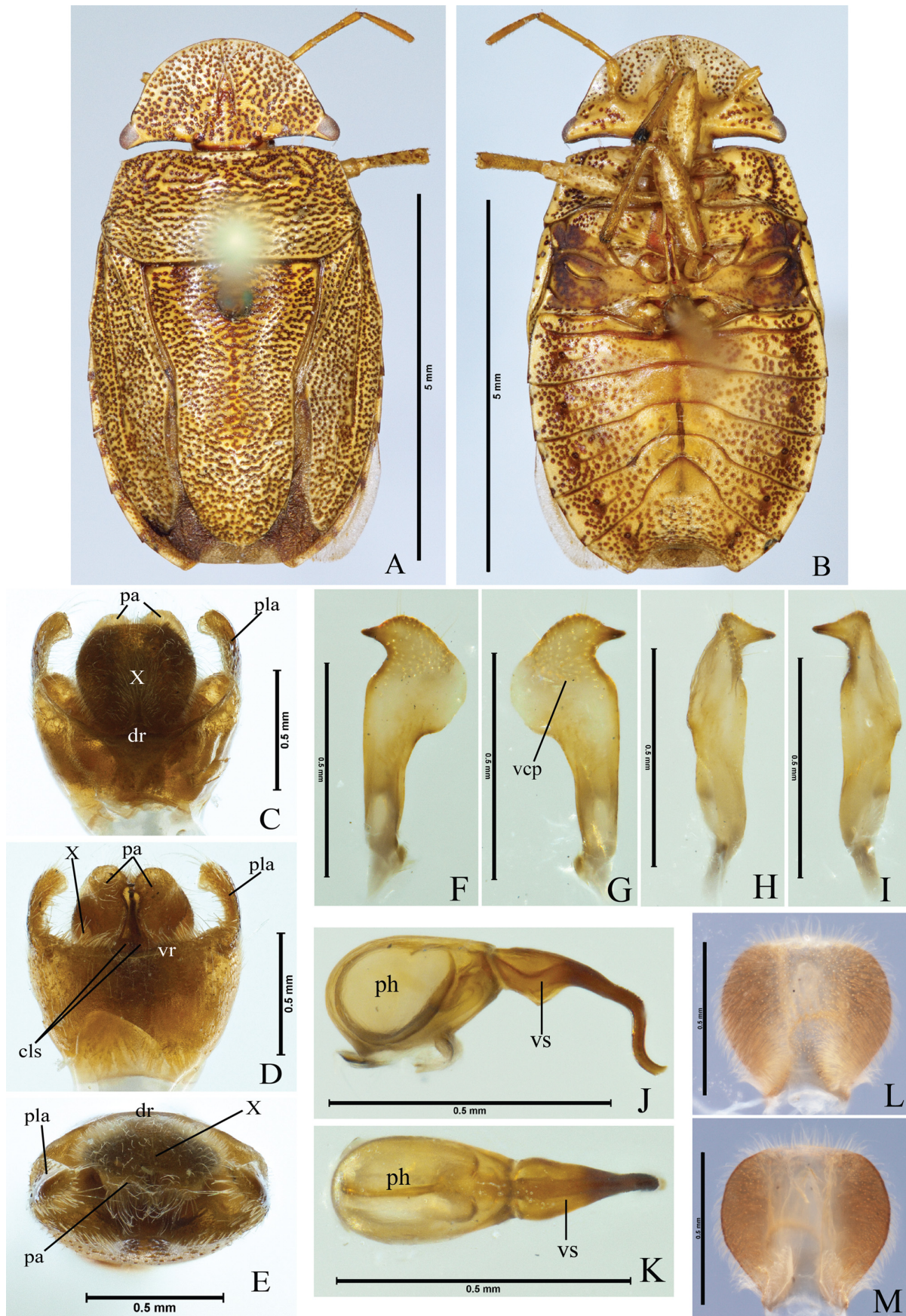

FIGURE 24. *Ischnopelta cristulata* Rosso & Campos, sp. n. Holotype male. A, dorsal view; B, ventral view; C–E, pygophore: dorsal, ventral, and posterior views respectively; F–I, parameters: dorsal, ventral, external and internal lateral views, respectively; J–K, phallus: lateral and dorsal views, respectively; L–M, segment X, dorsal and ventral views, respectively. Abbreviations: cls, cup like sclerites; dr, dorsal rim; pa, parameter; ph, phalloteca; pla, posterolateral angle; vcp, ventral crest; vr, ventral rim; vs, vesica; X, segment X.

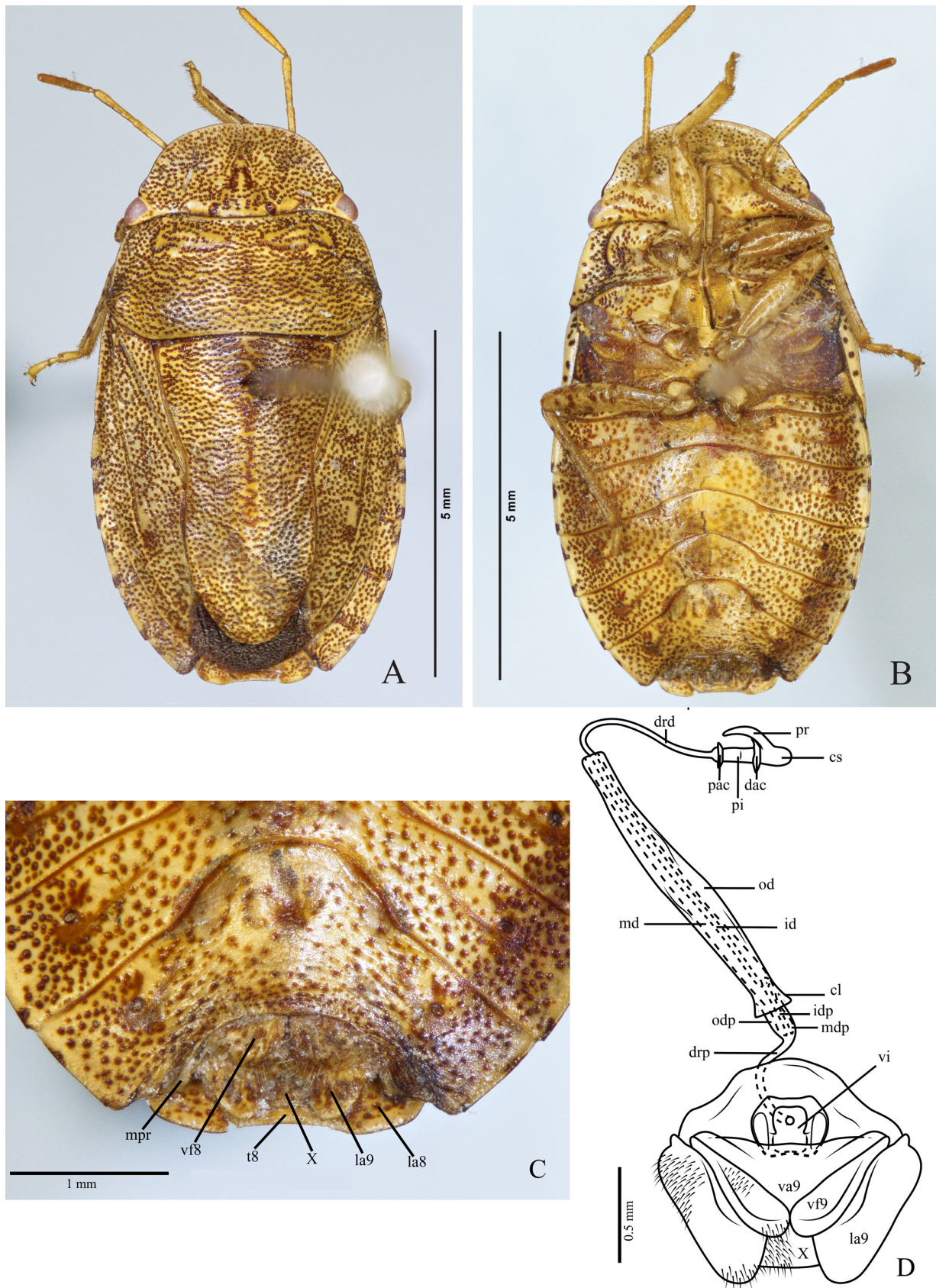

FIGURE 25. *Ischnopelta cristulata* Rosso & Campos, sp. n. Female. A, dorsal view; B, ventral view; C, genital plates ventroposterior view (45°); D, internal genitalia. Abbreviations: cl, collar; cs, seminalis capsule; dac, distal annular crest; drd, distal ductus receptaculi; drp, proximal ductus receptaculi; id, internal duct; idp, proximal internal duct; la8, laterotergite VIII; la9, laterotergite IX; md, medium duct; mdp, proximal medium duct; mpr, projection on the lateral third of posterior margin of sternite VII; od, external duct; odp, proximal external duct; pac, proximal annular crest; pi, pars intermedialis; pr, projection; t8, mediotergite VIII; va9, valvulae IX; vf8, valvifer VIII; vf9, valvifer IX; vi, thickening of vaginal intima; X, segment X.

TABLE 9. Measurements (mean, standard deviation, minimum and maximum) and number of *Ischnopelta cristulata* Rosso & Campos, sp. n. specimens evaluated (n).

Body structure	Measurements performed		Male	n	Female
		n	Measurements (mm)		Measurements (mm)
Body	tl	6	6.94±0.67; (5.74–7.55)	13	8.30±0.34; (7.59–8.90)
	mw		4.07±0.28; (3.71–4.41)		4.65±0.18; (4.23–4.86)
Head	hl	6	1.53±0.07; (1.45–1.66)	14	1.65±0.07; (1.51–1.74)
	cl		0.54±0.02; (0.50–0.57)		0.60±0.02; (0.56–0.64)
	hw		3.12±0.15; (2.93–3.31)		3.41±0.11; (3.20–3.64)
	iod		0.82±0.05; (0.75–0.88)		0.91±0.03; (0.86–0.97)
	ied		2.52±0.13; (2.36–2.69)		2.77±0.09; (2.59–2.94)
	pl		1.54±0.08; (1.45–1.64)		1.76±0.07; (1.65–1.92)
Pronotum	haw	6	3.57±0.21; (3.32–3.84)	13	4.03±0.16; (3.71–4.26)
	aaw		2.99±0.13; (2.86–3.17)		3.39±0.14; (3.16–3.61)
	sl		3.90±0.23; (3.62–4.16)		4.61±0.22; (4.21–5.01)
Scutellum	fll	6	1.58±0.05; (1.49–1.64)	14	1.85±0.08; (1.70–2.01)
	pfl		2.33±0.21; (2.03–2.55)		2.77±0.16; (2.51–3.05)
	bsw		2.34±0.13; (2.14–2.48)		2.65±0.10; (2.46–2.82)
	fcw		1.61±0.07; (1.51–1.69)		1.88±0.08; (1.70–2.06)
	I		0.44±0.03; (0.40–0.47)		0.46±0.03; (0.43–0.50)
Antennae	II	4	0.49±0.04; (0.43–0.53)	7	0.54±0.02; (0.53–0.58)
	III		0.75±0.03; (0.71–0.79)		0.79±0.05; (0.74–0.87)
	IV		0.92±0.04; (0.87–0.96)		0.97±0.03; (0.94–1.02)
	V		1.19±0.02; (1.18–1.21)		1.22±0.04; (1.18–1.27)
	I		0.58±0.02; (0.56–0.61)		0.63±0.03; (0.61–0.68)
Labium	II	5	1.24±0.04; (1.19–1.30)	6	1.36±0.02; (1.33–1.40)
	III		0.57±0.05; (0.50–0.62)		0.58±0.02; (0.56–0.61)
	IV		0.36±0.03; (0.31–0.40)		0.42±0.02; (0.40–0.43)

Legend: tl, total length; mw, maximum width (at the sternite III level); hl, head length; cl, clypeus length; hw, head width; iod, interocellar distance; ied, interocular distance; pl, pronotum length; haw, pronotum width at the level of humeral angles; aaw, pronotum width at the level of anterolateral angles; sl, scutellum length; fll, frenal lobe length; pfl, post-frenal lobe length; bsw, basal scutellum width; fcw, scutellum width at the level of frenal constriction; I, II, III, IV and V, antennal and labium segments length.

setae on distal portion of sutural margins and on median half of posterior margin (Figs. 5H; 25C, vf8). Valvifers IX covered by valvifers VIII, lateral margin convex; setae on mid-basal portion of ventral surface (Fig. 25D, vf9). Laterotergites IX not reaching the posterior margin of mediotergite VIII; lateral margin subrectilinear; setae on mid-basal portion of lateral margin and ventral surface (Fig. 25C–D, la9). Thickening of vaginal intima wider than long; distal margin more sclerotized and slightly concave; lateral margins convex, broad mid-basal area membranous (Fig. 25D, vi). Vesicular area: anterior portion to the collar 1/9 of posterior portion, median duct anterior to the collar with slight proximal widening (Fig. 25D, mdp); median duct posterior to the collar with proximal widening (Fig. 25D, md); inner duct curved, almost coiled, in the proximal widening (Fig. 25D, id). Distal ductus receptaculi 0.5 times the length of vesicular area posterior to the collar (Fig. 25D, drd, drp). Pars

intermedialis cylindrical (Fig. 25D, pi); annular crests perpendicular to the pars intermedialis, the distal 1/3 larger than proximal one (Fig. 25D, dac, pac). Capsula seminalis globose with a long filiform lateral projection directed to the pars intermedialis (Fig. 25D, cs, pr).

Measurements: Table 9.

Distribution. Brazil (Rondônia, Mato Grosso, Mato Grosso do Sul) (Fig. 7).

Comments. *Ischnopelta cristulata* is distinguished from *I. coralinae* sp. n., *I. impunctata* sp. n., *I. luteicornis*, *I. parvula* sp. n., *I. pellucidula* sp. n. and *I. ruckesi* sp. n., by the subrectilinear and transverse crest on the ventral surface of parameres (Figs. 18D, G, vcp; 24G, vcp; 29D, G, vcp; 31D, G, vcp; 39D, vcp; 43B, E, vcp; 44D, G, vcp). See comments in *I. coralinae* sp. n.

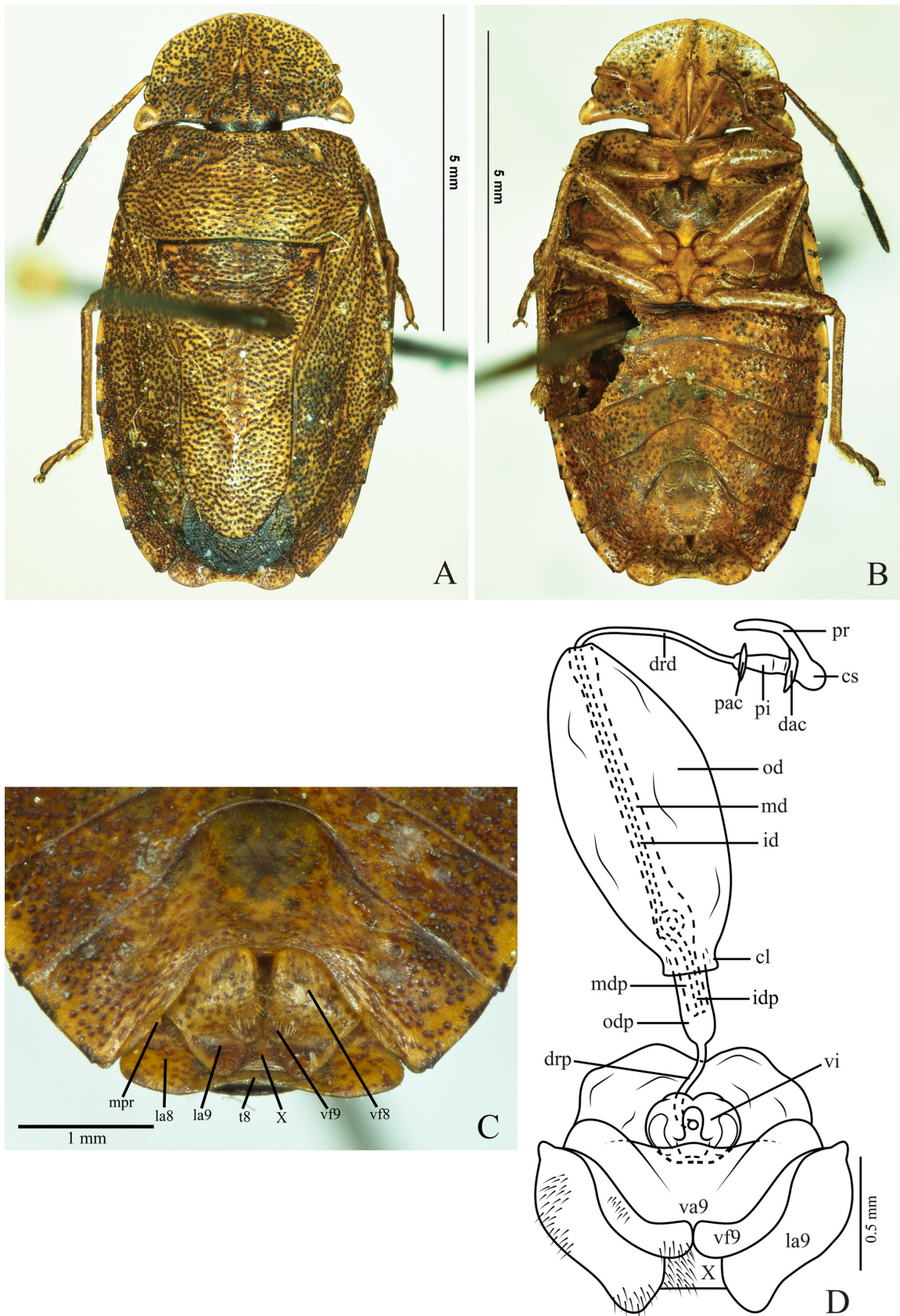

FIGURE 26. *Ischnopelta cylindrata* Rosso & Campos, sp. n. Holotype female. A, dorsal view; B, ventral view; C, genital plates ventroposterior view (45°); D, internal genitalia. Abbreviations: cl, collar; cs, seminalis capsule; dac, distal annular crest; drd, distal ductus receptaculi; drp, proximal ductus receptaculi; id, internal duct; idp, proximal internal duct; la8, laterotergite VIII; la9, laterotergite IX; md, medium duct; mdp, proximal medium duct; mpr, projection on the lateral third of posterior margin of sternite VII; od, external duct; odp, proximal external duct; pac, proximal annular crest; pi, pars intermedialis; pr, projection; t8, mediotergite VIII; va9, valvulae IX; vf8, valvifer VIII; vf9, valvifer IX; vi, thickening of vaginal intima; X, segment X.

Ischnopelta cylindrata Rosso & Campos, sp. n. (Figs. 5E, 26)

Etymology. The epithet refers to the uniform cylindrical shape of the female inner duct of the vesicular area. Latin: *cylindratus* = cylinder shape, cylindrical.

Type locality. BRAZIL, *Minas Gerais*, Ouro Preto, [-20.3874, -43.5067].

Holotype. Female. BRAZIL, *Minas Gerais*, Ouro Preto (Topázios), 22.XI.1962, J. Bechyné col. Deposited at Museu de Zoologia da Universidade de São Paulo (MZSP), São Paulo (SP), Brazil.

Other material examined. One female abdomen whose determination as *I. cylindrata* was made by comparison of the valvifers VIII, enabling the examination of the internal genitalia.

Description. The overall somatic morphology is as described for *I. scutellata*, except for the following features. Body densely punctured, brownish. Head. Ventral surface of mandibular plates with minute dark brown to black punctures, and long and thick setae on

mid-apical band. Maxillary plates and ocular peduncles densely punctured. Bucculae slightly higher than the first labial segment. Labrum inserted posteriorly to half the distance between the anterior margin of the eyes and the apex of mandibular plates. Antennae segment I dark yellowish with brown blotches, segments II and III brown ventrally and dark yellowish dorsally, segment III dorsally punctured, segments IV and V dark brown; antennal segment ratio: I>II<III<IV<V.

Thorax. Hemelytra: corium as long as scutellum; minute spot at apex of radial. Pro- and mesosternum punctured, metasternum unpunctured. Pro-, meso- and metapleura densely punctured.

Abdomen. Dark spots at the lateral of urosternites subtriangular.

Male. Unknown.

Female. Membrane of hemelytra with apical margin convex, dark brown, not reaching the posterior margin of mediotergite VIII; median portion of posterior margin of mediotergite VIII concave; median portion of posterior margin of urosternite VII subrectilinear; projections on the

TABLE 10. Measurements and number of *Ischnopelta cylindrata* Rosso & Campos. sp. n. specimens evaluated (n).

Body structure	Measurements performed	Male		Female	
		n	Measurements (mm)	n	Measurements (mm)
Body	tl	–	–	1	9.19
	mw	–	–	–	4.67
Head	hl	–	–	–	1.96
	cl	–	–	–	0.56
	hw	–	–	1	3.73
	iod	–	–	–	2.74
	ied	–	–	–	1.02
Pronotum	pl	–	–	–	1.72
	haw	–	–	1	4.02
	aaw	–	–	–	3.52
Scutellum	sl	–	–	–	4.83
	fl	–	–	–	1.93
	pfl	–	–	1	2.90
	bsw	–	–	–	2.65
	fcw	–	–	–	1.83
Antennae	I	–	–	–	0.56
	II	–	–	–	0.43
	III	–	–	1	0.74
	IV	–	–	–	0.81
	V	–	–	–	1.21
Labium	I	–	–	–	0.62
	II	–	–	–	1.30
	III	–	–	1	0.56
	IV	–	–	–	0.34

Legend: tl. total length; mw. maximum width (at the sternite III level); hl. head length; cl. clypeus length; hw. head width; iod. interocellar distance; ied. interocular distance; pl. pronotum length; haw. pronotum width at the level of humeral angles; aaw. pronotum width at the level of anterolateral angles; sl. scutellum length; fl. frenal lobe length; pfl. post-frenal lobe length; bsw. basal scutellum width; fcw; scutellum width at the level of frenal constriction; I. II. III. IV and V. antennal and labium segments length.

lateral 1/3 of the posterior margin of urosternite VII long and narrow, and perpendicular to the surface of urosternite VII (Fig. 26C, mpr). **Genitalia.** Valvifers VIII wider than long; posterior margin subrectilinear and transversal to the median line, cut obliquely on the lateral; sutural margins subrectilinear and folded dorsally; surface dark yellowish with dense brown punctures, dorsoposteriorly curved on distal portion; setae long on median half of posterior margin and on posterior half of the sutural margin; basal portion with narrow and shallow longitudinal grooves (Figs. 5E; 26C, vf8). Valvifers IX exposed; lateral margin convex; sparse setae on mid-basal portion of ventral surface (Fig. 26C–D, vf9). Laterotergites IX not reaching the posterior margin of mediotergite VIII; lateral margin sinuous; setae on median portion of lateral margin and on mid-basal portion of ventral surface (Fig. 26C–D, la9). Thickening of vaginal intima wider than long; cordiform and distally emarginated; lateral margins strongly convex; median area with small membranous cone (Fig. 26D, vi). Vesicular area: anterior portion to the collar 1/8 of the posterior portion; median duct anterior to the collar cylindrical (Fig. 26D, mdp); median duct posterior to the collar with proximal and distal widening (Fig. 26D, md); inner duct coiled in the proximal widening (Fig. 26D, id). Distal ductus receptaculi 0.4 the length of the vesicular area posterior to the collar (Fig. 26D, drd, drp). Pars intermedialis barrel-shaped (Fig. 26D, pi). Annular crests slightly convergent, the proximal one slightly larger than half the diameter of the distal one (Fig. 26D, dac, pac). Capsula seminalis globose, with one laterobasal filiform projection surpassing the proximal annular crest (Fig. 26D, cs, pr).

Measurements: Table 10.

Distribution. Brazil (Minas Gerais) (Fig. 6).

Comments. *Ischnopelta cylindrata* sp. n. differs from other species by the mandibular plates wider anterolaterally, with ventral minute punctures (Fig. 26A–B) and thicker mid-apical setae about 3 times longer than observed in other species. This is the only species in the genus whose median duct of the vesicular area is cylindrical anterior to the collar (Fig. 26D, mdp).

***Ischnopelta guarani* Rosso & Campos, sp. n.** (Figs. 5S, 27–28)

Etymology. The epithet is a tribute to the Guarani, a native people of South America, in whose original lands occurs the species.

Type locality. ARGENTINA, *Corrientes*, Laguna Brava [-27.4957, -58.6441].

Holotype. Male. ARGENTINA, *Corrientes*, Laguna Brava (7 km E Corrientes, Route 5), 18.I.1989, C.W. & L.B. O'Brien & G. Wibmer. Deposited at Museo de La Plata, Universidad Nacional de La Plata (MLPA), La Plata, Argentina.

Paratypes. 5 males and 2 females. BOLIVIA, *Santa Cruz*, Warnes (5 km SSE Warnes, Rio Selva Hotel), 2 males, 20–21.X.2000, Morris & Wappers, [-17.561111, -63.1994444], (J.E. Eger, Private collection);

PARAGUAY, *Alto Paraguai* (Grand Chaco, 250 km West Paraguay River), 1 male, 28.VI.1936, Alberto Schulze, [-23.366667, -59.6667], (USNM); *Central*, Capiatá, 1 female, 15.I.1991, G. Arriagada, [-25.3500, -57.4167], (J.E. Eger, Private collection); *Vila Elisa*, 1 female, 2.XII.1939, Dernier Coll., [-25.3667, -57.6167], (MLPA); ARGENTINA, *Formosa*, Laishi (Riacho Tohué), 2 males, 11.I.1939, Dernier Coll., [-26.408333, -58.258333], (MLPA).

Description. The overall somatic morphology is as described for *I. scutellata*, except for the following features. Head. Antennae: segment I dark yellowish with brown blotches; segments II and III dark yellowish with brown punctures, ventral surface brown in some specimens; segments IV and V dark brown, proximal portion of segment IV dark yellowish with brown punctures in some specimens; segments ratio: I=II<III<IV<V.

Thorax. Scutellum: post-frenal lobe margins subparallel to the distal half. Hemelytra: conspicuous spot at apex of radial vein.

Abdomen pale-yellow; dark spots at the lateral of urosternites elongated and subtriangular, both wide and subequal in length.

Male. Apical margin of membrane of hemelytra convex; median portion of the posterior margin of urosternite VII concave; urosternite VII reaching anteriorly the imaginary line connecting the spiracles of urosternite V. **Genitalia.** Pygophore with dorsal and ventral rim slightly concave (Figs. 27C, dr; 27D, vr). Posterolateral angles 1.4 times longer than the rest of the pygophore, perpendicular to the frontal plane and subparallel, apices slightly convergent, basal portion of the dorsal margin less sclerotized and folded to the interior of the pygophore (Fig. 27C–E, pla). Setae in a band on the ventral rim, part of the lateral surface of the pygophore, and the lateral of the posterolateral angles; setae long on ventral rim and ventral margin of the posterolateral angles. Segment X longer than wide, not reaching the apex of the posterolateral angles and parameres; oval and weakly emarginated apically; lateral margins sclerotized and densely covered with long setae; mid-longitudinal portion membranous with short and sparse setae (Figs. 27C–E, X; 27L–M). Parameres claviform, oblique to the frontal plane, outer margin sinuous, convex on apical portion; inner margin sinuous, with a shallow cavity more sclerotized on the distal portion; apical margin convex forming a convergent process with the inner margin; dorsal and ventral surfaces sinuous, setae covering a narrow band on the sclerotized area of the inner margin (Figs. 27D, pa; 27F–I). Cup-like sclerites externally visible, apices rounded and subparallel. Phallus: vesica sharply sinuous, proximal portion directed posteriorly, sharply curved ventroanteriorly on median portion, and curved ventroposteriorly on distal portion; basal portion laterally widened, short, dorsally flat, ventrally expanded, and gradually narrowing posteriorly; secondary gonopore beveled (Fig. 27J–K).

Female. Membrane of hemelytra not reaching the posterior margin of mediotergite VIII, posterior margin convex; posterior margin of mediotergite VIII and of

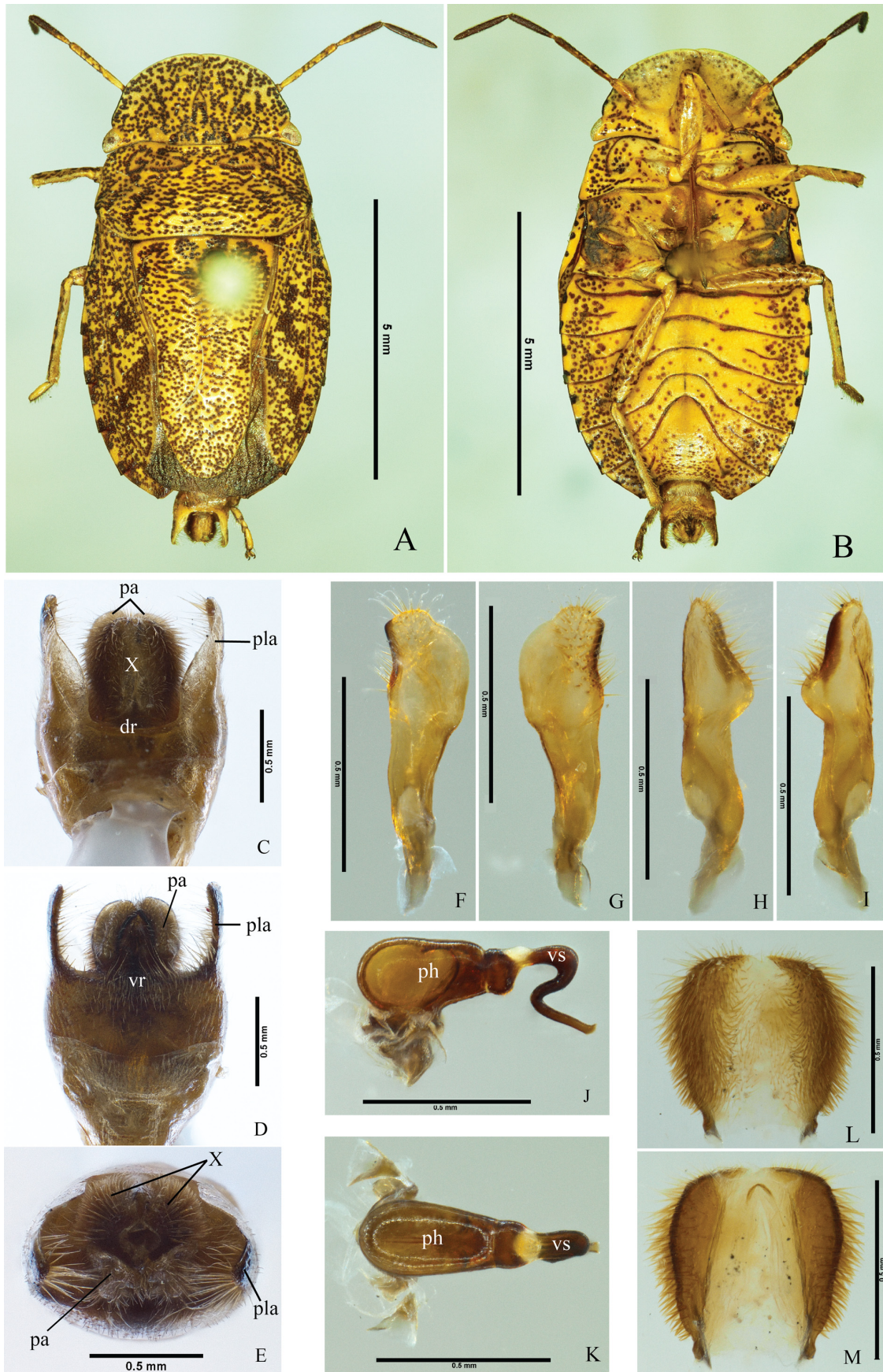

FIGURE 27. *Ischnopelta guarani* Rosso & Campos, sp. n. Holotype male. A, dorsal view; B, ventral view, C–E, pygophore: dorsal, ventral, and posterior views respectively; F–I, parameters: dorsal, ventral, external and internal lateral views, respectively; J–K, phallus: lateral and dorsal views, respectively; L–M, segment X, dorsal and ventral views, respectively. Abbreviations: dr, dorsal rim; pa, parameter; ph, phalloteca; pla, posterolateral angle; vr, ventral rim; vs, vesica; X, segment X.

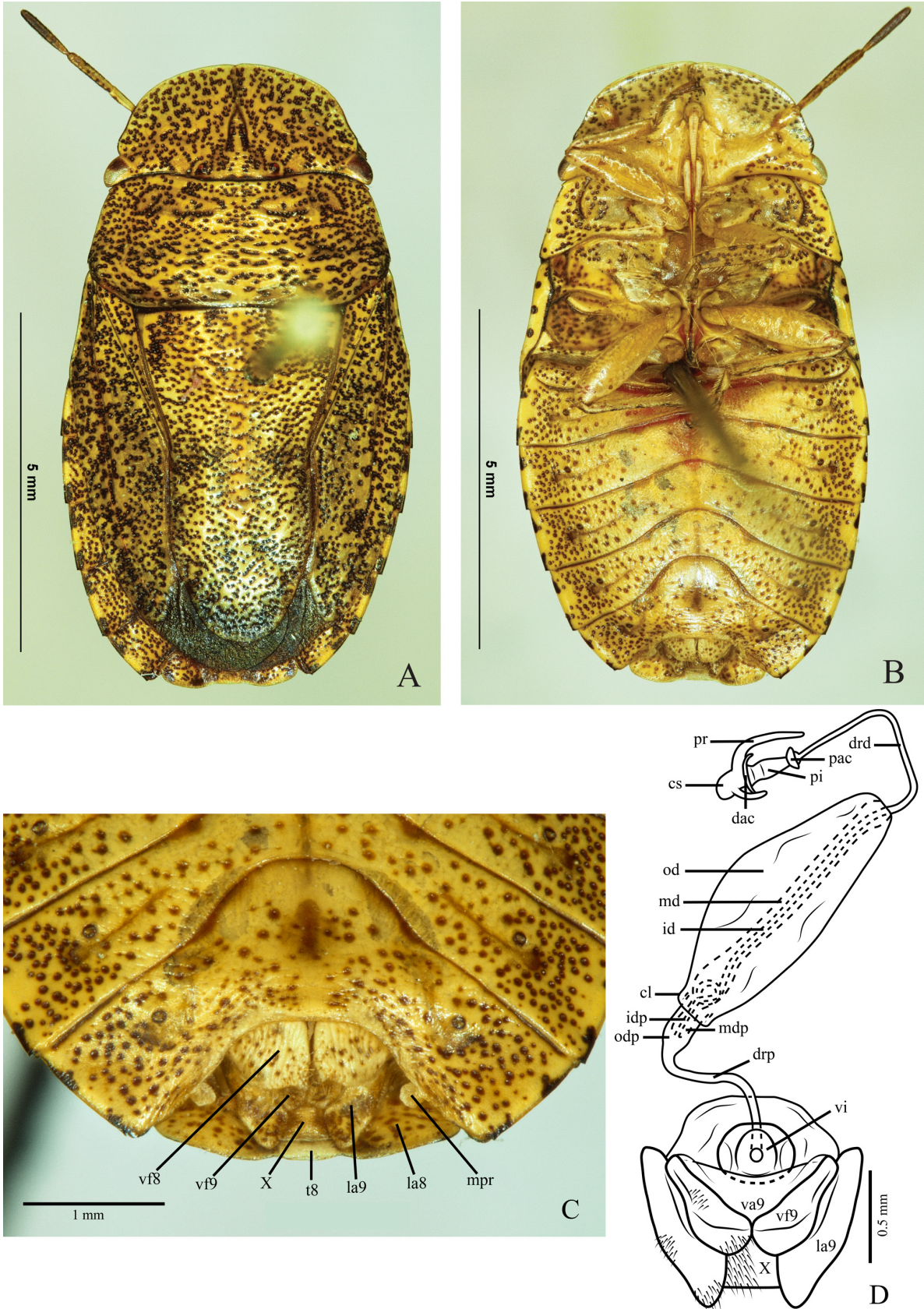

FIGURE 28. *Ischnopelta guarani* Rosso & Campos, sp. n. Female. A, dorsal view; B, ventral view; C, genital plates ventroposterior view (45°); D, internal genitalia. Abbreviations: cl, collar; cs, seminalis capsule; dac, distal annular crest; drd, distal ductus receptaculi; drp, proximal ductus receptaculi; id, internal duct; idp, proximal internal duct; la8, laterotergite VIII; la9, laterotergite IX; md, medium duct; mdp, proximal medium duct; mpr, projection on the lateral third of posterior margin of sternite VII; od, external duct; odp, proximal external duct; pac, proximal annular crest; pi, pars intermedialis; pr, projection; t8, mediotergite VIII; va9, valvulae IX; vf8, valvifer VIII; vf9, valvifer IX; vi, thickening of vaginal intima; X, segment X.

TABLE 11. Measurements (mean, standard deviation, minimum and maximum) and number of *Ischnopelta guarani* Rosso & Campos, sp. n. specimens evaluated (n).

Body structure	Measurements performed	Male		Female	
		n	Measurements (mm)	n	Measurements (mm)
Body	tl	6	7.96±0.31; (7.44–8.24)	2	9.50±0.14; (9.40–9.60)
	mw		4.40±0.24; (3.94–4.60)		5.30±0.03; (5.28–5.32)
Head	hl	6	1.76±0.11; (1.68–1.98)	2	1.95±0.09; (1.89–2.02)
	cl		0.59±0.02; (0.57–0.60)		0.67±0.01; (0.66–0.67)
	hw		3.56±0.17; (3.23–3.74)		4.04±0.03; (4.02–4.06)
	iod		0.96±0.06; (0.85–1.01)		1.11±0.03; (1.09–1.13)
	ied		2.89±0.12; (2.67–3.00)		3.33±0.14; (3.23–3.43)
	pl		1.68±0.05; (1.63–1.77)		1.88±0.05; (1.84–1.91)
Pronotum	haw	6	3.86±0.20; (3.51–4.08)	2	4.54±0.01; (4.53–4.55)
	aaw		3.42±0.18; (3.12–3.65)		3.95±0.10; (3.88–4.02)
	sl		4.38±0.21; (4.03–4.61)		5.07±0.03; (5.05–5.10)
Scutellum	fll	6	1.73±0.12; (1.55–1.86)	2	2.02±0.00; (2.02–2.02)
	pfl		2.65±0.11; (2.48–2.80)		3.05±0.03; (3.03–3.07)
	bsw		2.52±0.15; (2.24–2.63)		3.01±0.06; (2.97–3.05)
	fcw		1.71±0.10; (1.55–1.85)		2.13±0.06; (2.08–2.17)
	I		0.50±0.04; (0.47–0.56)		0.56±0.00; (0.56–0.56)
Antennae	II	5	0.48±0.02; (0.46–0.51)	2	0.56±0.00; (0.56–0.56)
	III		0.78±0.06; (0.68–0.84)		0.87±0.00; (0.87–0.87)
	IV		0.87±0.07; (0.74–0.93)		0.98±0.02; (0.96–0.99)
	V	2	1.07±0.02; (1.05–1.09)	1	1.12
	Labium	I	5	0.61±0.02; (0.59–0.62)	2
II		1.30±0.03; (1.27–1.33)		1.38±0.02; (1.36–1.40)	
III		0.49±0.01; (0.47–0.50)		0.64±0.02; (0.62–0.65)	
IV		0.37±0.01; (0.34–0.37)		0.36±0.02; (0.34–0.37)	

Legend: tl, total length; mw, maximum width (at the sternite III level); hl, head length; cl, clypeus length; hw, head width; iod, interocellar distance; ied, interocular distance; pl, pronotum length; haw, pronotum width at the level of humeral angles; aaw, pronotum width at the level of anterolateral angles; sl, scutellum length; fll, frenal lobe length; pfl, post-frenal lobe length; bsw, basal scutellum width; fcw, scutellum width at the level of frenal constriction; I, II, III, IV and V, antennal and labium segments length.

urosternite VII, and projections of urosternite VII as described for *I. scutellata*, but the later perpendicular to the surface of urosternite VII (Fig. 28C, mpr). **Genitalia.** Valvifers VIII wider than long; posterior margin sinuous; sutural margins subrectilinear and dorsally folded; surface convex longitudinally, dark yellowish with brown punctures, setae on distal half of sutural margins and on posterior margin; longitudinal grooves narrow and shallow (Figs. 5S; 28C, vf8). Valvifers IX partially covered by valvifers VIII; lateral margin sinuous, mid-basal portion of ventral surface without setae (Fig. 28D, vf9). Laterotergites IX not reaching the posterior margin of mediotergite VIII; lateral margin convex; setae on median portion of lateral margin (Fig. 28C–D, la9). Thickening of vaginal intima subcircular, median area broadly oval and membranous (Fig. 28D, vi). Vesicular area anterior to the collar 1/8 of the posterior portion; median duct anterior to the collar with slight proximal widening (Fig. 28D,

mdp), median duct posterior to the collar with proximal and distal widening (Fig. 28D, md), inner duct coiled in the proximal widening (Fig. 28D, id). Distal ductus receptaculi narrower than proximal one, and 0.9 times the length of the vesicular area posterior to the collar (Fig. 28D, drd, drp). Pars intermedialis barrel-shaped (Fig. 28D, pi); annular crests directed to the ductus receptaculi, the proximal slightly larger than half the diameter of the distal one (Fig. 28D, dac, pac). Capsula seminalis oval, with two filiform projections, one laterobasal long and sinuous, and the other shorter, midlateral, both directed to the pars intermedialis (Fig. 28D, cs, pr).

Measurements: Table 11.

Distribution. Bolivia (Santa Cruz), Paraguay (Alto Paraguay, Central), Argentina (Formosa, Corrientes) (Fig. 7).

Comments. *Ischnopelta guarani* sp. n. (Fig. 27A–B; 28A–B) is similar to *I. paiagua* sp. n. (Fig. 38A–B),

differing by the labrum inserted slightly posteriorly to half the distance between the anterior margin of the eyes and the apex of mandibular plates, the wider abdominal lateral blotches, and the shape of the parameres (Figs. 27F–I; 38F–I).

***Ischnopelta impunctata* Rosso & Campos, sp. n.**
(Figs. 5F, 29–30)

Etymology. The epithet refers to the absence of punctures in large areas of the median region of the abdomen. Latin: *im-* = not, without + *punctum* = small point, punctures.

Type Locality. BRAZIL, *Piauí*, Piripiri [-4.0989, -41.0981].

Holotype. Male. BRAZIL, *Piauí*, Piripiri (Parque Nacional Sete Cidades), 31.I.2007, I.S. Carvalho. Deposited at the collection of Universidade Federal of Pará (UFPA), Belém (PA), Brazil.

Paratypes. 9 males and 9 females. BRAZIL, *Maranhão*, São Luiz, 1 female, 13.III.1984, A. Brisola Col., [-2.5325, -44.2963], (UNIFESP); 1 female, 22.V.1984, A. Brisola Col., [-2.5325, -44.2963], (UNIFESP); 1 male and 2 females, 08.VII.1987, A. Brisola Col., [-2.5325, -44.2963], (UNIFESP); *Piauí*, Piripiri (Parque Nacional Sete Cidades), 1 male, 12.XII.2006, I.S. Carvalho, [-4.1256, -41.7093], (UFPA); 5 males and 2 females, 31.I.2007, I.S. Carvalho, [-4.0989, -41.0981], (UFPA); 1 female, 23.VI.2007, I.S. Carvalho, [-4.0989, -41.0981], (UFPA); *Maranhão*, Mirador (Parque Estadual Mirador, Posto Avançado do Mel), 1 female, 18–25.III.2012, F. Limeira de Oliveira & D. W. A. Marques, [-6.730556, -44.983056], (CZMA/UEMA); *Paraíba*, Juazeirinho, 1 male and 1 female, 26.VI.1956, A. G. A. Silva, [-6.730556, -44.983056], (MCNZ, Coleção Campos Seabra); *Piauí*, Uruçuí (Estrada Estadual de Uruçuí), 1 male, 2–26.V.1984, R. Gonçalves, [-7.2316, -44.5564], (DZUP).

Description. The overall somatic morphology is as described for *I. scutellata*, except for the following features. Head. Labrum inserted anteriorly to half the distance between the anterior margin of the eyes and the apex of mandibular plates. Antennae dark yellowish, slightly brown ventrally; segments ratio: I=II<III<IV<V.

Thorax. Hemelytra: corium as long as scutellum, conspicuous spot at apex of the radial vein. Pro-, meso- and metapleura dark yellowish, densely punctured on the laterals. Setae on posterodorsal margin of protibiae as long as the others.

Abdomen. Urosternites with the anterior lateral blotch slightly longer than the posterior one, both wide; median region of urosternites weakly punctured.

Male. Apical margin of membrane of hemelytra subrectilinear. Median portion of posterior margin of urosternite VII concave; urosternite VII not reaching anteriorly the imaginary line connecting the spiracles of urosternite V. **Genitalia.** Pygophore with dorsal rim concave (Fig. 29C, dr), ventral rim subrectilinear with a slight median depression extending to the ventral surface of the pygophore (Fig. 29C, vr). Posterolateral angles 1.6 times

longer than the rest of the pygophore, base perpendicular and apex oblique to the frontal plane, convergent from the base (Fig. 29C–E, pla). Setae short and sparse on posterior half of ventral and lateral surfaces of the genital capsule and on the outer surface of the posterolateral angles; setae long on ventral rim and on ventral and apical margins of posterolateral angles. Segment X slightly longer than wide, oval, reaching the apex of posterolateral angles and surpassing the apex of parameres; proximal portion and apical margin membranous; lateral margins strongly convex; surface sclerotized and covered with setae, with 1 + 1 lateroproximal tufts (Figs. 29C and E, X; 29L–M). Parameres falciform, flat, shorter than the posterolateral angles, subparallel to the frontal plane; basal portion of outer margin convex, apical portion strongly convex; inner margin sinuous, distal portion strongly excavated and with an apical aculeiform process, convergent and ventrolaterally directed; apical margin convex; ventral surface with an oblique crest (Fig. 47B and E, vcp); setae covering the crest and the posterior region (Figs. 29D, pa; 29F–I). Cup-like sclerites externally visible and with convergent apices (Fig. 29D, cls). Phallus: proximal 2/3 of vesica directed ventroposteriorly, base as wide as apical margin of the phallosome and gradually narrowing, with a ventral subtriangular expansion; distal portion directed ventrally; secondary gonopore ventral and beveled (Fig. 29J–K).

Female. Membrane of hemelytra surpassing the posterior margin of mediotergite VIII, posterior margin convex; posterior margin of mediotergite VIII and of urosternite VII, and projections of urosternite VII laminate as described for *I. scutellata* (Fig. 30C, mpr). **Genitalia.** Valvifers VIII wider than long; posterior margin slightly sinuous, weakly folded dorsally, with small projection on the lateral angle; sutural margins subrectilinear and folded dorsally; surface dark yellowish, with punctures and brown blotches; setae on distal portion of sutural margins and on median half of posterior margin; longitudinal grooves narrow and shallow on basal portion (Figs. 5F; 30C, vf8). Apices of valvifers IX externally visible; lateral margin convex; setae on mid-basal portion of ventral surface (Fig. 30C–D, vf9). Laterotergites IX not reaching the posterior margin of mediotergite VIII; lateral margin convex; setae on mid-basal portion of lateral margin and ventral surface (Fig. 30C–D, la9). Thickening of vaginal intima hexagonal, slightly wider than long; distal portion more sclerotized; mid-basal subquadrangular area membranous (Fig. 30D, vi). Vesicular area anterior to the collar 1/10 of the posterior portion; median duct with slight proximal widening both anterior and posterior to the collar (Fig. 30D, md, mdp); inner duct not coiled (Fig. 30D, id). Distal ductus receptaculi of same caliber as the proximal one (Fig. 30D, drd, drp). Pars intermedialis uniformly wide (Fig. 30D, pi); proximal annular crest perpendicular to the pars intermedialis, the distal one directed to the pars intermedialis and twice the diameter of the proximal crest (Fig. 30D, dac, pac). Capsula seminalis globose and with a laterobasal projection filiform directed to the pars intermedialis (Fig. 30D, cs, pr).

Measurements: Table 12.

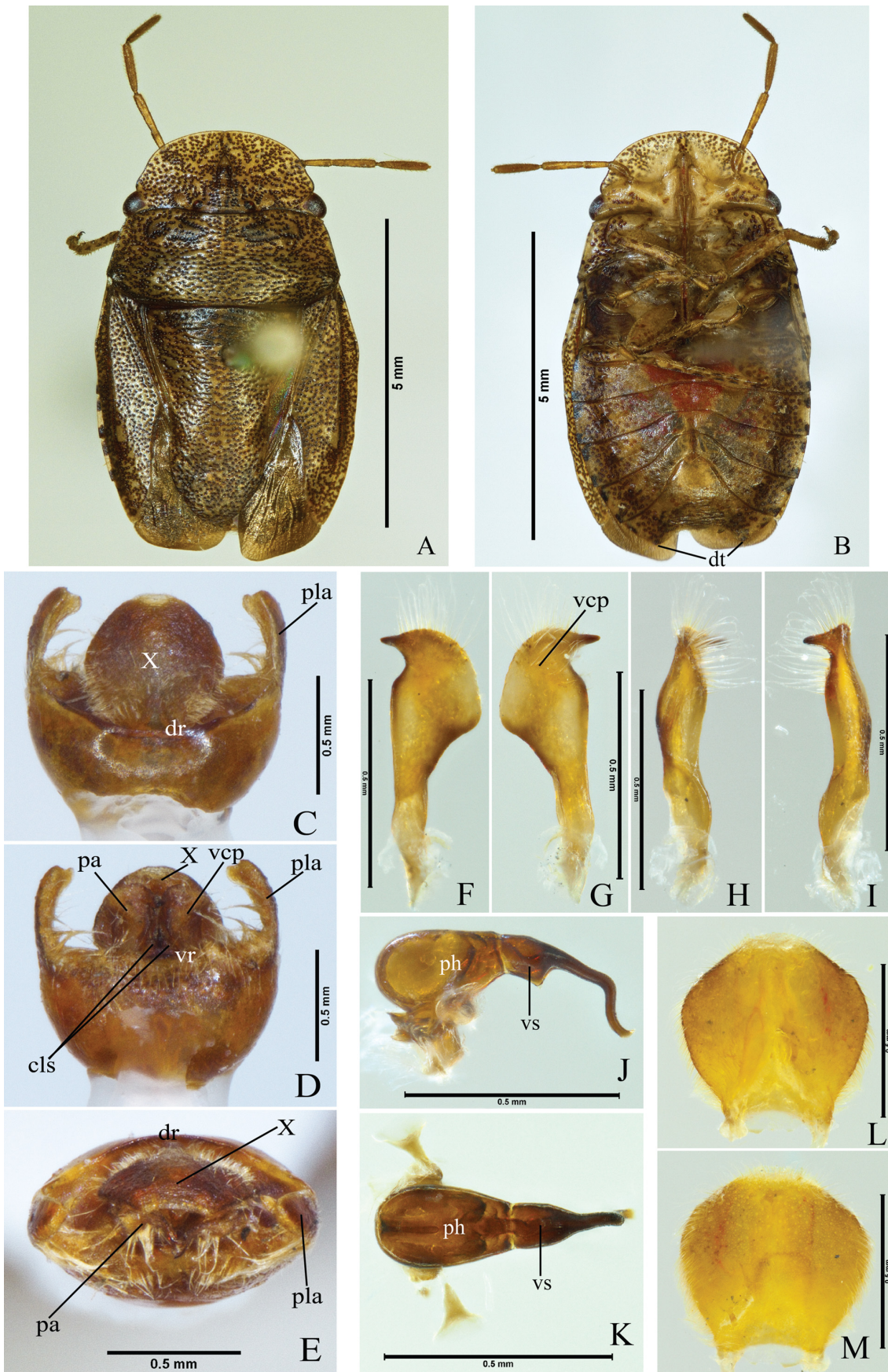

FIGURE 29. *Ischnopelta impunctata* Rosso & Campos, sp. n. Holotype male. A, dorsal view; B, ventral view; C–E, pygophore: dorsal, ventral, and posterior views respectively; F–I, parameters: dorsal, ventral, external and internal lateral views, respectively; J–K, phallus: lateral and dorsal views, respectively; L–M, segment X, dorsal and ventral views, respectively. Abbreviations: cls, cup like sclerites; dr, dorsal rim; dt, denticles; pa, parameter; ph, phalloteca; pla, posterolateral angle; vcp, ventral crest; vr, ventral rim; vs, vesica; X, segment X.

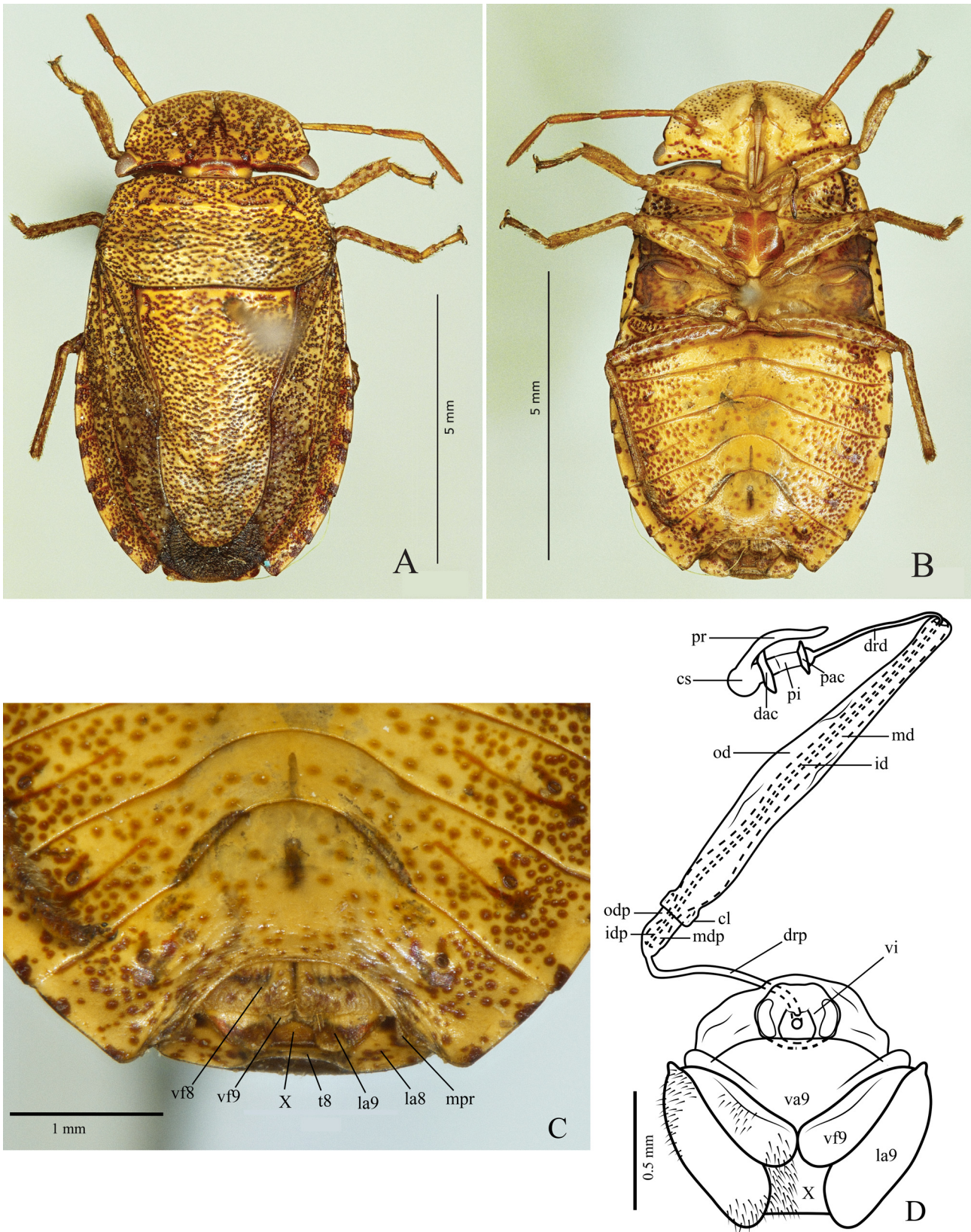

FIGURE 30. *Ischnopelta impunctata* Rosso & Campos, sp. n. Female. A, dorsal view; B, ventral view; C, genital plates ventroposterior view (45°); D, internal genitalia. Abbreviations: cl, collar; cs, seminalis capsule; dac, distal annular crest; drd, distal ductus receptaculi; drp, proximal ductus receptaculi; id, internal duct; idp, proximal internal duct; la8, laterotergite VIII; la9, laterotergite IX; md, medium duct; mdp, proximal medium duct; mpr, projection on the lateral third of posterior margin of sternite VII; od, external duct; odp, proximal external duct; pac, proximal annular crest; pi, pars intermedialis; pr, projection; t8, mediotergite VIII; va9, valvulae IX; vf8, valvifer VIII; vf9, valvifer IX; vi, thickening of vaginal intima; X, segment X.

TABLE 12. Measurements (mean, standard deviation, minimum and maximum) and number of *Ischnopelta impunctata* Rosso & Campos, sp. n. specimens evaluated (n).

Body structure	Measurements performed	Male		Female	
		n	Measurements (mm)	n	Measurements (mm)
Body	tl	6	7.02±0.45; (6.51–7.77)	7	8.02±0.24; (7.77–8.51)
	mw		3.89±0.36; (3.55–4.51)		4.37±0.31; (3.85–4.78)
Head	hl	6	1.53±0.10; (1.44–1.71)	8	1.63±0.09; (1.55–1.76)
	cl		0.53±0.04; (0.47–0.58)		0.58±0.03; (0.54–0.61)
	hw		3.07±0.28; (2.74–3.56)		3.32±0.14; (3.13–3.51)
	iod		0.84±0.05; (0.79–0.92)		0.91±0.05; (0.86–1.01)
	ied		2.45±0.22; (2.23–2.86)		2.65±0.14; (2.41–2.81)
	pl		1.55±0.10; (1.41–1.70)		1.70±0.10; (1.63–1.88)
Pronotum	haw	6	3.58±0.31; (3.33–4.14)	8	3.90±0.23; (3.63–4.22)
	aaw		3.08±0.28; (2.74–3.55)		3.25±0.18; (3.03–3.55)
	sl		3.84±0.39; (3.48–4.51)		4.41±0.29; (4.00–4.96)
Scutellum	fl	6	1.67±0.18; (1.48–2.00)	8	1.85±0.10; (1.70–2.03)
	pfl		2.17±0.23; (1.85–2.52)		2.47±0.11; (2.29–2.66)
	bsw		2.34±0.20; (2.07–2.66)		2.64±0.16; (2.49–2.96)
	fcw		1.55±0.18; (1.33–1.85)		1.71±0.11; (1.63–1.89)
	I		0.40±0.04; (0.36–0.47)		0.42±0.02; (0.40–0.43)
Antennae	II	5	0.37±0.03; (0.36–0.43)	8	0.43±0.02; (0.40–0.47)
	III		0.72±0.05; (0.68–0.79)		0.74±0.03; (0.68–0.76)
	IV	4	0.81±0.05; (0.76–0.86)	7	0.86±0.04; (0.83–0.90)
	V		1.01±0.05; (0.97–1.04)		1.05±0.03; (1.02–1.08)
	Labium	I	6	0.61±0.07; (0.54–0.68)	8
II		1.36±0.12; (1.26–1.51)		1.32±0.05; (1.22–1.40)	
III		0.57±0.04; (0.50–0.61)		0.55±0.05; (0.47–0.61)	
IV		0.38±0.02; (0.36–0.40)		0.38±0.02; (0.36–0.40)	

Legend: tl, total length; mw, maximum width (at the sternite III level); hl, head length; cl, clypeus length; hw, head width; iod, interocellar distance; ied, interocular distance; pl, pronotum length; haw, pronotum width at the level of humeral angles; aaw, pronotum width at the level of anterolateral angles; sl, scutellum length; fl, frenal lobe length; pfl, post-frenal lobe length; bsw, basal scutellum width; fcw, scutellum width at the level of frenal constriction; I, II, III, IV and V, antennal and labium segments length.

Distribution. Brazil (Maranhão, Piauí, Ceará, Paraíba) (Fig 7).

Comments. Among the species grouped with *I. coralinae* sp. n. (see comments for the latter), *Ischnopelta impunctata* sp. n. is the only one having wide blotches on the laterals of the urosternites, and armed urosternite VII (Figs. 29B, dt; 30B). In relation to the females of the group, *I. impunctata* sp. n. differs by the membrane of hemelytra surpassing the posterior margin of mediotergite VIII, and the median abdominal region weakly punctured (Fig. 30A–B). Among males, *I. impunctata* sp. n. and *I. parvula* sp. n. are the only species with subrectilinear margin of the hemelytral membrane (Figs. 29A–B; 39A–B).

***Ischnopelta luteicornis* (Walker, 1867)** (Figs. 5G, 31–32)

Discocephala luteicornis Walker, 1867: 185; Lethierry & Severin, 1893: 84; Kirkaldy, 1909: 215; Rolston, 1990: 24.

Ischnopelta luteicornis: Becker & Grazia, 1992: 203; Grazia *et al.*, 2015: 712.

Lectotype. Male. BRAZIL. The Natural History Museum (British Museum) (NHMUK), London, United Kingdom.

Paralectotypes. 2 females. BRAZIL, *Pará*, Santarém. The National History Museum (British Museum) (NHMUK), London, United Kingdom.

Material examined: BRAZIL, *Pará*, Santarém, 1 male, (holotype, det. H. Ruckes, 1960), [-2.4359, -54.7156], (UFRG); 1 female, 3.IV.1956, Elias & Roppa Col., (holotype, det. VI.1995), [-2.4359, -54.7156], (MNRJ).

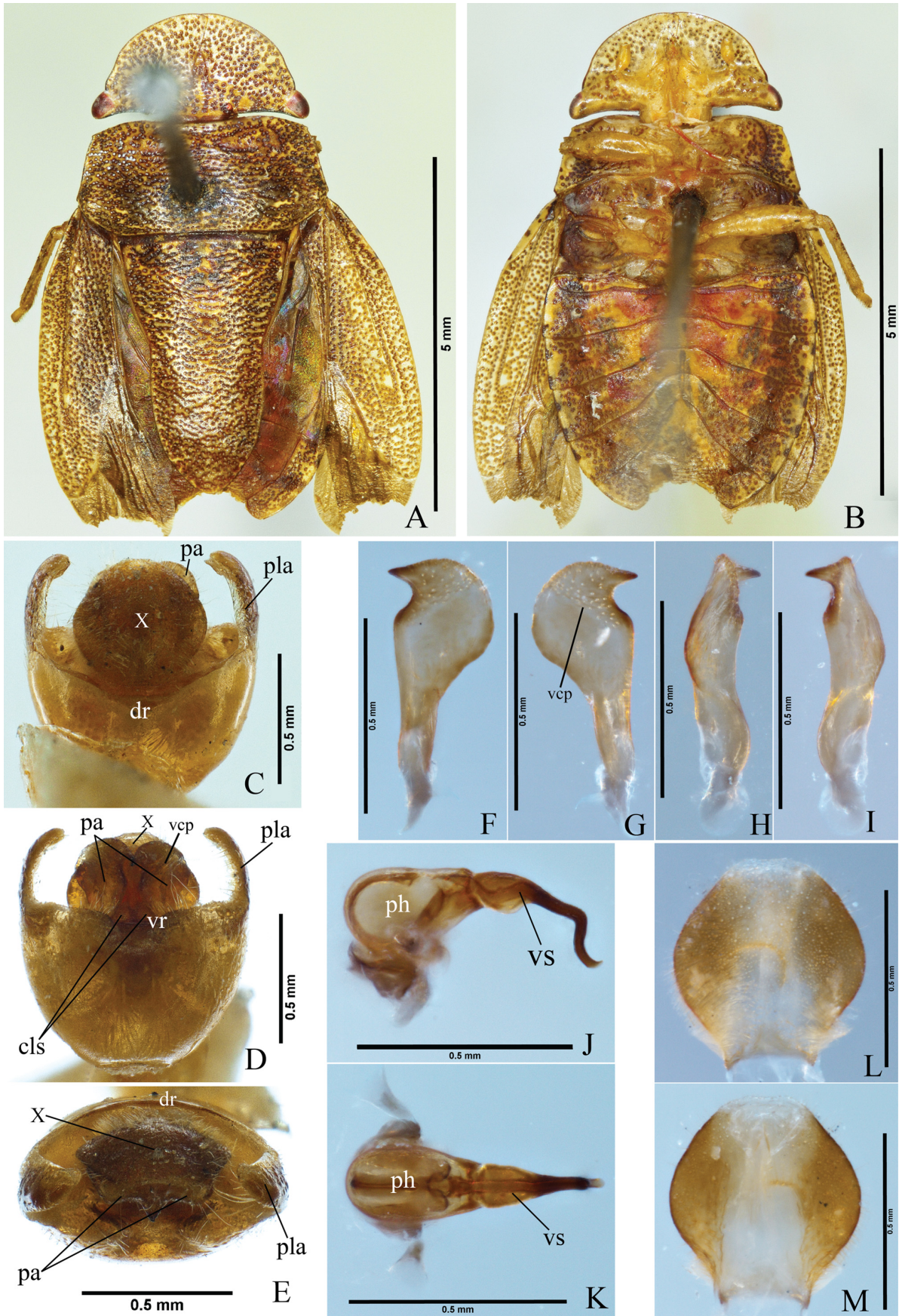

FIGURE 31. *Ischnopelta luteicornis* (Walker, 1867). Male. A, dorsal view; B, ventral view; C–E, pygophore: dorsal, ventral, and posterior views respectively; F–I, parameters: dorsal, ventral, external and internal lateral views, respectively; J–K, phallus: lateral and dorsal views, respectively; L–M, segment X, dorsal and ventral views, respectively. Abbreviations: cls, cup like sclerites; dr, dorsal rim; pa, parameter; ph, phalloteca; pla, posterolateral angle; vcp, ventral crest; vr, ventral rim; vs, vesica; X, segment X.

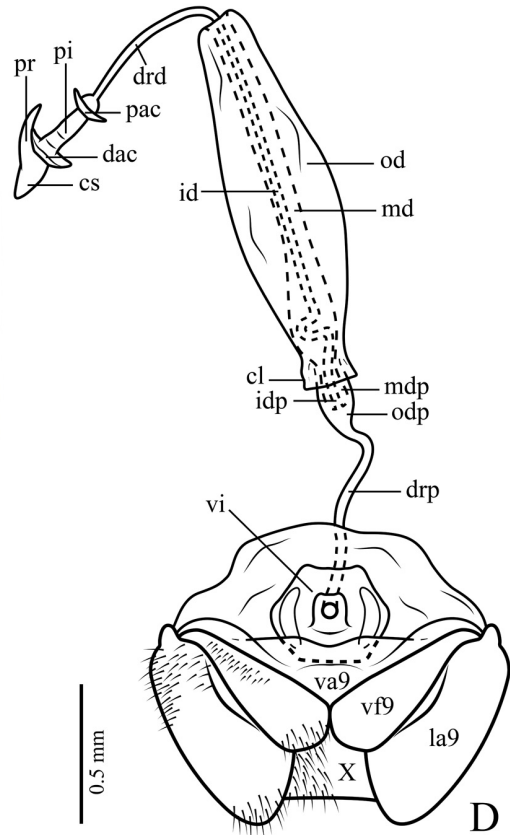
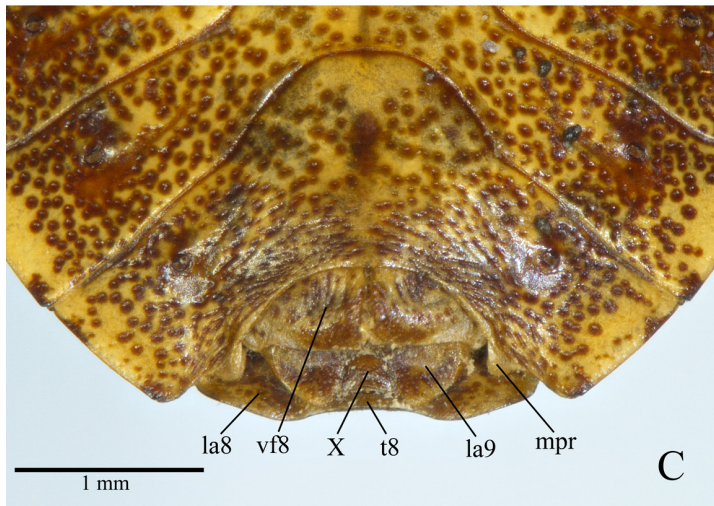

FIGURE 32. *Ischnopelta luteicornis* (Walker, 1867). Female. A, dorsal view; B, ventral view; C, genital plates ventroposterior view (45°); D, internal genitalia. Abbreviations: cl, collar; cs, seminalis capsule; dac, distal annular crest; drd, distal ductus receptaculi; drp, proximal ductus receptaculi; id, internal duct; idp, proximal internal duct; la8, laterotergite VIII; la9, laterotergite IX; md, medium duct; mdp, proximal medium duct; mpr, projection on the lateral third of posterior margin of sternite VII; od, external duct; odp, proximal external duct; pac, proximal annular crest; pi, pars intermedialis; pr, projection; t8, mediotergite VIII; va9, valvulae IX; vf8, valvifer VIII; vf9, valvifer IX; vi, thickening of vaginal intima; X, segment X.

Description. The overall somatic morphology is as described for *I. scutellata*, except for the following features. Body densely punctured, brownish. Head. Labrum inserted anteriorly to half the distance between the anterior margin of the eyes and the apex of mandibular plates. Antennae dark yellowish and unpunctured; segments ratio: I<II<III-?-?.

Thorax. Scutellum reaching the apical angles of urosternite VI. Hemelytra: corium as long a scutellum; minute spot at apex of radial vein. Pro-, meso-, and metapleura dark yellowish. Setae on posterodorsal margin of protibiae as long as the others.

Abdomen. Urosternite VII unarmed.

Male. Median portion of posterior margin of urosternite VII concave; urosternite VII reaching anteriorly the imaginary line connecting the spiracles of sternite V. **Genitalia.** Pygophore with dorsal rim concave (Fig. 31C, dr); ventral rim sinuous, moderately excavated (Fig. 31D, vr). Posterolateral angles 1.5 times longer than the the rest of the pygophore, base perpendicular and apex oblique to the frontal plane, convergent from the base (Fig. 31C–E,

pla). Setae short and sparse on posterior half of ventral and lateral surfaces of pygophore, and on outer surface of the posterolateral angles. Segment X slightly longer than wide, not reaching the apex of posterolateral angles and parameres; slightly oval; surface covered by setae, sclerotized on the laterals, basal portion and apical margin membranous (Figs. 31C–E, X; 31L–M). Parameres falciform, flat, slightly shorter than the posterolateral angles; subparallel to the frontal plane; outer margin strongly convex; inner margin sinuous, distal portion strongly excavated and with an apical aculeiform process, convergent and directed ventrolaterally; apical margin convex; ventral surface with an oblique crest delimiting a small apical area (Fig. 31D and G, vcp); setae covering the crest and the area posterior to it (Figs. 31D, pa; 31F–I). Cup-like sclerites externally visible and with convergent apices (Fig. 31D, cls). Phallus: proximal portion of vesica broader, dorsally flat and slightly expanded ventrally; median portion flat, broader anteriorly, directed ventroposteriorly; distal portion subcylindrical; secondary gonopore ventral and beveled (Fig. 31J–K).

TABLE 13. Measurements and number of *Ischnopelta luteicornis* (Walker, 1867) specimens evaluated (n).

Body structure	Measurements performed	Male		Female	
		n	Measurements (mm)	n	Measurements (mm)
Body	tl	1	7.87	1	8.47
	mw		3.99		4.73
Head	hl	1	1.52	1	1.75
	cl		0.48		0.61
	hw		3.12		3.60
	iod		0.83		1.00
	ied		2.47		2.94
Pronotum	pl	1	1.62	1	1.78
	haw		3.61		4.21
	aaw		3.08		3.50
Scutellum	sl	1	3.81	1	4.63
	fl		1.60		1.94
	pfl		2.21		2.69
	bsw		2.38		2.78
	fcw		1.60		1.94
Antennae	I	1	0.4	1	0.43
	II	–	–	1	0.54
	III		–	0.79	
	IV		–	–	
	V		–	–	
Labium	I	1	0.40	1	0.68
	II		1.19		1.19
	III		0.58		0.58
	IV		0.40		0.43

Legend: tl. total length; mw. maximum width (at the sternite III level); hl. head length; cl. clypeus length; hw. head width; iod. interocellar distance; ied. interocular distance; pl. pronotum length; haw. pronotum width at the level of humeral angles; aaw. pronotum width at the level of anterolateral angles; sl. scutellum length; fl. frenal lobe length; pfl. post-frenal lobe length; bsw. basal scutellum width; fcw; scutellum width at the level of frenal constriction; I. II. III. IV and V. antennal and labium segments length.

Female. Membrane of hemelytra not reaching the posterior margin of mediotergite VIII, posterior margin convex; median portion of posterior margin of mediotergite VIII subrectilinear; median portion of posterior margin of urosternite VII concave; projections on the lateral 1/3 of posterior margin of urosternite VII thick and perpendicular to the urosternite surface (Fig. 32C, mpr). **Genitalia.** Valvifers VIII wider than long; posterior margin subrectilinear and slightly oblique to the median line; sutural margins subrectilinear and folded dorsally; surface dark yellowish, with punctures and brown blotches; setae sparse on distal half of sutural margins and on median half of posterior margin; longitudinal grooves narrow and shallow on basal portion (Figs. 5G; 32C, vf8). Apices of valvifers IX partially visible; lateral margin subrectilinear; setae on mid-basal portion of ventral surface (Fig. 32D, vf9). Laterotergites IX not reaching the posterior margin of mediotergite VIII; lateral margin convex; setae on mid-basal portion of lateral margin and ventral surface (Fig. 32C–D, la9). Thickening of vaginal intima hexagonal; slightly wider than long; distal portion more sclerotized, mid-basal subrectangular area membranous; distal margin slightly concave (Fig. 32D, vi). Vesicular area anterior to the collar 1/8 of posterior portion; median duct anterior to the collar with slight proximal widening (Fig. 32D, mdp), median duct posterior to the collar with proximal widening, inner duct curved, almost coiled, in the proximal widening (Fig. 32D, id). Distal ductus receptaculi of same caliber as the proximal (Fig. 32D, drd, drp). Pars intermedialis cylindrical (Fig. 32D, pi); distal annular crest larger than the proximal one, both directed to the ductus receptaculi (Fig. 32D, dac, pac). Capsula seminalis elongated, subconical and with a filiform laterobasal projection (Fig. 32D, cs, pr).

Measurements: Table 13.

Distribution. Brazil (Pará) (Fig. 7).

Comments. Among the species grouped with *I. coralinae* sp. n. (see comments for the latter), females of *Ischnopelta luteicornis* are the only whose projections of the posterior margin of urosternite VII are thick and perpendicular to the surface of the urosternite (Fig. 32C, mpr). The males of *I. luteicornis* are the only in this group whose urosternite VII reaches anteriorly the imaginary line connecting the spiracles of urosternite V (Fig. 31B).

***Ischnopelta magna* Rosso & Campos, sp. n.** (Figs. 5D and 33)

Etymology. The epithet refers to the large size of this species compared to all other in *Ischnopelta*. Latin *magnus* = large.

Type Locality. ARGENTINA, *Jujuy*, Jujuy, [-24.1946, -65.2971].

Holotype. Female. ARGENTINA, *Jujuy*, Jujuy. Deposited at the Museo Argentino de Ciencias Naturales “Bernardino Rivadavia” (MACN), Buenos Aires, Argentina.

Description. The overall somatic morphology is as described for *I. scutellata*, except for the following

features. Body densely punctured, brownish. Head. Labium reaching the metacoxae, segment IV dark brown. Labrum inserted posteriorly to half the distance between the anterior margin of the eyes and the apex of mandibular plates. Antennae: segments I to III dark yellowish, segments IV and V dark brown; segments ratio: I>II<III=IV<V.

Thorax. Scutellum reaching the apical angles of urosternite VI. Hemelytra: corium as long as scutellum; conspicuous spot at apex of radial vein. Mesosternum punctured. Pro-, meso- and metapleura dark yellowish and densely punctured. Setae on posterodorsal margin of protibiae as long as the others.

Abdomen. Dark spots at the lateral of urosternites subequal in length and irregular in shape, both wide.

Male. Unknown.

Female. Membrane of hemelytra not reaching the posterior margin of mediotergite VIII, dark-brown, apical margin convex; median portion of posterior margin of mediotergite VIII and of urosternite VII concave; projections on the lateral 1/3 of posterior margin of urosternite VII thick and perpendicular to the surface of the urosternite (Fig. 33C, mpr). **Genitalia.** Valvifers VIII as wide as long; posterior margin sinuous; sutural margins slightly convex and folded dorsally; surface dark yellowish with punctures and brown blotches, longitudinal grooves narrow and shallow on basal surface, wide and deep groove forming a fold on the distal half of sutural rim, setae sparse on posterior half of sutural margins (Figs. 5D; 33C, vf8). Valvifers IX covered by valvifers VIII. Laterotergites IX not reaching the posterior margin of mediotergite VIII; visible portion dark yellowish with brown punctures (Fig. 33C, la9). Internal genitalia not examined.

Measurements: Table 14.

Distribution. Argentina (*Jujuy*) (Fig. 7).

Comments. *Ischnopelta magna* sp. n. (Fig. 33A–B) is similar to *I. cylindrata* sp. n. (Fig. 26A–B), differing in the larger size, the antennal length, and the size of the lateral blotches of the urosternites. The fold on the distal half of sutural margins of valvifers VIII in *I. magna* sp. n. is the characteristic that best distinguish both species (Figs. 5D; 33C, vf8). This folding is also found in *I. confusa* sp. n. (Figs. 5C; 17C, vf8) though less pronounced, and *I. confusa* sp. n. differentiates from *I. magna* sp. n. by the laminate, oblique projections on the posterior margin of urosternite VII (Fig. 17C, mpr), the unpunctured mesosternum, and the bucculae concealing the first labial segment.

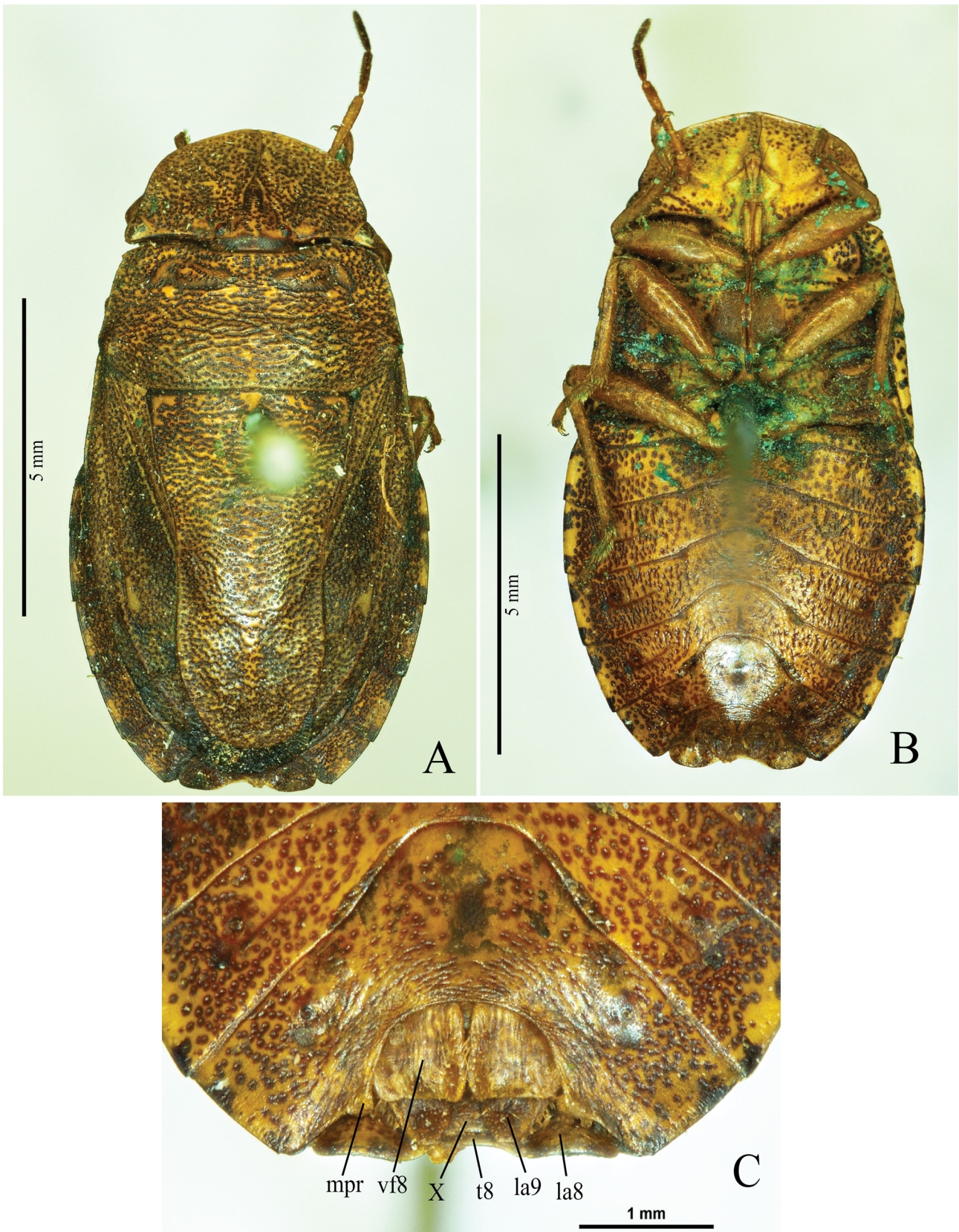

FIGURE 33. *Ischnopelta magna* Rosso & Campos, sp. n. Holotype female: A, dorsal view; B, ventral view; C, genital plates ventroposterior view (45°). Abbreviations: la8, laterotergite VIII; la9, laterotergite IX; mpr, projection on the lateral third of posterior margin of sternite VII; t8, mediotergite VIII; vf8, valvifer VIII; X, segment X.

TABLE 14. Measurements and number of *Ischnopelta magna* Rosso & Campos. sp. n. specimens evaluated (n).

Body structure	Measurements performed	Male		Female	
		n	Measurements (mm)	n	Measurements (mm)
Body	tl	–	–	1	10.62
	mw	–	–	1	5.81
Head	hl	–	–		2.30
	cl	–	–		0.63
	hw	–	–	1	4.07
	iod	–	–		1.90
	ied	–	–		3.35
Pronotum	pl	–	–		2.22
	haw	–	–	1	4.77
	aaw	–	–		4.11
Scutellum	sl	–	–		5.91
	fll	–	–		2.21
	pfl	–	–	1	3.70
	bsw	–	–		3.27
	fcw	–	–		2.42
Antennae	I	–	–		0.62
	II	–	–		0.47
	III	–	–	1	0.93
	IV	–	–		0.93
	V	–	–		1.24
Labium	I	–	–		0.68
	II	–	–	1	1.36
	III	–	–		0.62
	IV	–	–		0.40

Legend: tl. total length; mw. maximum width (at the sternite III level); hl. head length; cl. clypeus length; hw. head width; iod. interocellar distance; ied. interocular distance; pl. pronotum length; haw. pronotum width at the level of humeral angles; aaw. pronotum width at the level of anterolateral angles; sl. scutellum length; fll. frenal lobe length; pfl. post-frenal lobe length; bsw. basal scutellum width; fcw. scutellum width at the level of frenal constriction; I. II. III. IV and V. antennal and labium segments length

***Ischnopelta marginella* Rosso & Campos, sp. n.**
(Figs. 5T, 34–35)

Etymology. Epithet proposed by Dr. H. Ruckes as registered in the manuscripts found with the specimens used in the study. He considered this species having both the head and scutellum broadly rounded. In this species the apex of the head, and in some specimens also the apex of the scutellum, is emarginated, from which the epithet is inferred. Latin: *margino* = margin, emarginated + *ellus* = diminutive.

Type locality. ARGENTINA, *Salta*, Urundel [-23.5562, -64.3978].

Holotype. Male. ARGENTINA, *Salta*, Urundel, 2.XII.1934, Birabén Coll. Deposited at Museo de La Plata, Universidad Nacional de La Plata (MLPA), La Plata, Argentina.

Paratypes. 9 males and 18 females. BOLÍVIA, *La Paz*, Nor Yungas, 2 males and 1 female, 4.V.1931, Dernier Coll., [-16.182222, -55.383333], (MLPA); *Santa*

Cruz, Colorado River (Amboró National Park), 1 female, VII.1921–III.1922, Mulford Bio. Expl., [-17.675, -63.875], (USNM); ARGENTINA, *Salta*, Orán, 2 females, 22.V.1947, Birabén Coll., [-23.1340, -64.3246], (MLPA); 1 female, [-23.1340, -64.3246], (MACN); Urundel, 4 females, 2.XII.1934, Birabén Coll., [-23.5562, -64.3978], (MLPA); *Jujuy*, La Mendieta, 1 females, 27.XII.1939, Dernier Coll., [-26.8241, -65.2226], (MLPA); *Tucumán*, 1 female, 1956, C.J. Drake, [-26.8241, -65.2226], (USNM); *Santiago del Estero*, Santiago del Estero, 3 males and 4 females, 13.II.1929, [-27.7951, -64.2615], (MLPA); 1 female, 24.IX.1944, Maldonado Coll., [-27.7951, -64.2615], (MLPA); Loreto, 1 male, IX.1954, [-28.3019, -64.1803], (MLPA); *Córdoba*, Córdoba, 1 female, 17.II.1943, [-31.4, -64.183333], (MLPA); Vila Dolores, 3 males and 1 female, XII.1932, Comp. Col. Berg, [-31.9458, -65.1896], (MLPA).

Description. The overall somatic morphology is as described for *I. scutellata*, except for the following features. Head. Apex strongly emarginated on most specimens.

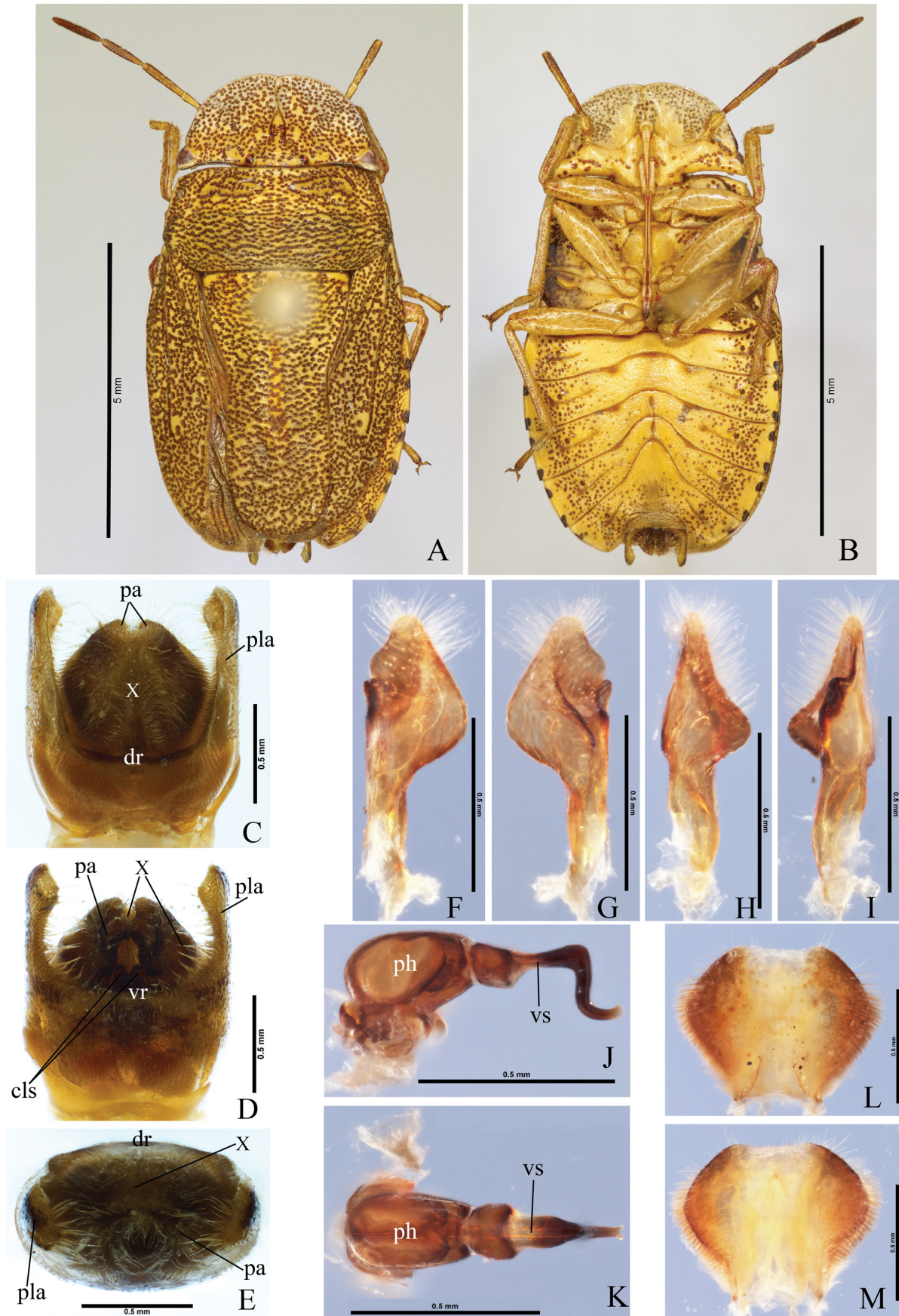

FIGURE 34. *Ischnopelta marginella* Rosso & Campos, sp. n. Holotype Male. A, dorsal view; B, ventral view; C–E, pygophore: dorsal, ventral and posterior views respectively; F–I, parameters: dorsal, ventral, external and internal lateral views, respectively; J–K, phallus: lateral and dorsal views, respectively; L–M, segment X, dorsal and ventral views, respectively. Abbreviations: cls, cup like sclerites; dr, dorsal rim; pa, parameter; ph, phalloteca; pla, posterolateral angle; vr, ventral rim; vs, vesica; X, segment X.

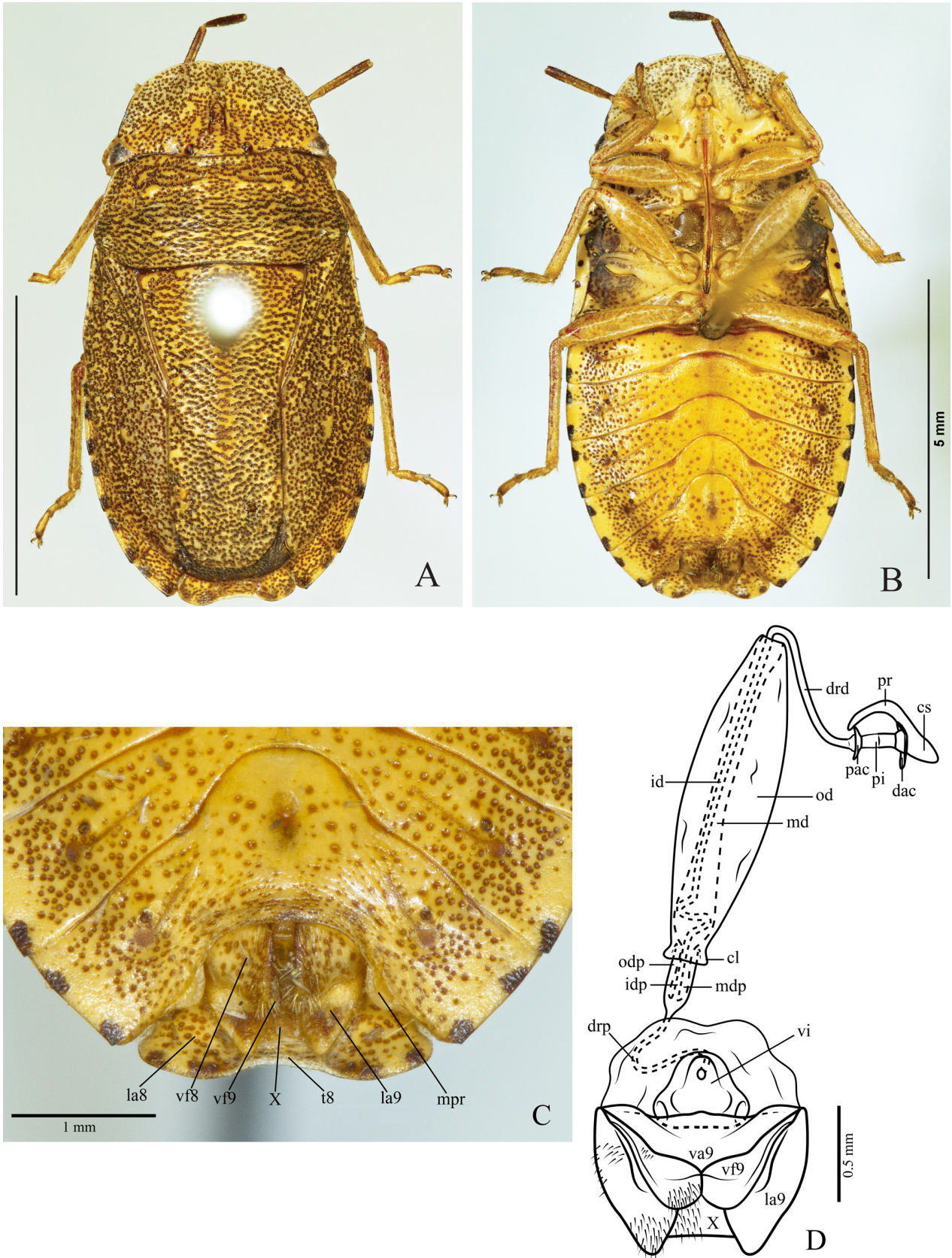

FIGURE 35. *Ischnopelta marginella* Rosso & Campos, sp. n. Female. A, dorsal view; B, ventral view; C, genital plates ventroposterior view (45°); D, internal genitalia. Abbreviations: cl, collar; cs, seminalis capsule; dac, distal annular crest; drd, distal ductus receptaculi; drp, proximal ductus receptaculi; id, internal duct; idp, proximal internal duct; la8, laterotergite VIII; la9, laterotergite IX; md, medium duct; mdp, proximal medium duct; mpr, projection on the lateral third of posterior margin of sternite VII; od, external duct; odp, proximal external duct; pac, proximal annular crest; pi, pars intermedialis; pr, projection; t8, mediotergite VIII; va9, valvulae IX; vf8, valvifer VIII; vf9, valvifer IX; vi, thickening of vaginal intima; X, segment X.

TABLE 15. Measurements (mean, standard deviation, minimum and maximum) and number of *Ischnopelta marginella* Rosso & Campos, sp. n. specimens evaluated (n).

Body structure	Measurements performed	Male		Female	
		n	Measurements (mm)	n	Measurements (mm)
Body	tl	10	7.85±0.26; (7.54–8.26)	19	8.89±0.41; (8.10–9.62)
	mw		4.39±0.12; (4.19–4.55)		4.83±0.20; (4.40–5.20)
Head	hl	10	1.77±0.09; (1.61–1.93)	20	1.77±0.07; (1.66–1.88)
	cl		0.58±0.02; (0.54–0.62)		0.60±0.03; (0.51–0.66)
	hw		3.43±0.09; (3.26–3.54)		3.59±0.11; (3.35–3.77)
	iod		0.96±0.03; (0.92–1.00)		1.01±0.04; (0.95–1.09)
	ied		2.77±0.08; (2.65–2.87)		2.90±0.09; (2.72–3.03)
	pl		1.74±0.05; (1.66–1.81)		1.87±0.08; (1.73–2.05)
Pronotum	haw	10	3.85±0.12; (3.63–4.03)	20	4.16±0.15; (3.90–4.52)
	aaw		3.32±0.08; (3.22–3.45)		3.52±0.14; (3.08–3.77)
	sl		4.52±0.13; (4.32–4.74)		5.00±0.23; (4.52–5.43)
Scutellum	fll	10	1.76±0.09; (1.65–1.90)	20	1.96±0.09; (1.78–2.11)
	pfl		2.77±0.08; (2.64–2.88)		3.04±0.16; (2.71–3.32)
	bsw		2.54±0.09; (2.35–2.68)		2.75±0.11; (2.56–2.93)
	fcw		1.69±0.04; (1.61–1.75)		1.86±0.09; (1.72–2.08)
	I		0.46±0.02; (0.43–0.50)		0.47±0.01; (0.47–0.50)
Antennae	II	6	0.42±0.03; (0.37–0.43)	8	0.44±0.02; (0.40–0.47)
	III		0.78±0.02; (0.74–0.81)		0.78±0.02; (0.74–0.81)
	IV	5	0.76±0.02; (0.74–0.78)	7	0.79±0.02; (0.78–0.81)
	V	3	1.03±0.02; (1.02–1.05)		1.02±0.04; (0.96–1.05)
	Labium	I	7	0.53±0.02; (0.50–0.56)	10
II		1.11±0.04; (1.09–1.18)		1.25±0.03; (1.21–1.27)	
III		0.49±0.04; (0.43–0.53)		0.52±0.02; (0.50–0.56)	
IV		6		0.29±0.02; (0.28–0.31)	

Legend: tl, total length; mw, maximum width (at the sternite III level); hl, head length; cl, clypeus length; hw, head width; iod, interocellar distance; ied, interocular distance; pl, pronotum length; haw, pronotum width at the level of humeral angles; aaw, pronotum width at the level of anterolateral angles; sl, scutellum length; fll, frenal lobe length; pfl, post-frenal lobe length; bsw, basal scutellum width; fcw, scutellum width at the level of frenal constriction; I, II, III, IV and V, antennal and labium segments length.

Bucculae as high as the first labial segment. Labium reaching the metacoxae. Labrum inserted posteriorly to half the distance between the anterior margin of the eyes and the apex of mandibular plates. Antennal segments I to III light-brown, segments IV and V dark brown; segments ratio: I>II<III=IV<V.

Thorax. Hemelytra: corium as long as scutellum; conspicuous spot at apex of radial vein. Legs pale-yellow, setae on posterodorsal margin of protibiae as long as the others.

Abdomen pale-yellow, dark spots at the lateral of urosternites subequal in length, both wide and drop-shaped; male urosternite VII unarmed.

Male. Apical margin of membrane of hemelytra and median portion of posterior margin of urosternite VII subrectilinear; urosternite VII reaching anteriorly the imaginary line connecting the spiracles of sternite V. **Genitalia.** Pygophore with dorsal and ventral rims

slightly concave (Figs. 34C, dr; 34C, vr). Posterolateral angles 1.8 times longer than the rest of the pygophore, perpendicular to the frontal plane and subparallel; apices slightly convergent (Fig. 34C–E, pla). Setae short and sparse on posterior half of ventral and lateral surfaces of the pygophore, and on the outer surface of posterolateral angles; setae long on ventral rim and on ventral margin of posterolateral angles. Segment X as long as wide, not reaching the apex of the posterolateral angles and the parameres; hexagonal; lateral margins sclerotized and covered by setae; mid-longitudinal area membranous and with sparse setae; apical margin membranous (Figs. 34C–E, X; 34L–M). Parameres claviform, subparallel to the frontal plane; basal portion with inner and outer margins subrectilinear and subparallel; head triangular, slightly swollen, inner margin sinuous with small and strongly sclerotized excavation; rounded apices; ventral surface with sinuous longitudinal crest, and setae on distal

half of the head (Figs. 34D, pa; 34F–I). Cup-like sclerites externally visible and with subparallel apices (Fig. 34D, cls). Phallus: proximal half of vesica posteriorly directed, proximal 1/3 as wide as the distal margin of phallosome, flattened dorsoventrally and cup-shaped, median 1/3 narrower, flattened dorsoventrally and little sclerotized, distal 1/3 conical and strongly sclerotized; distal half ventrally directed; secondary gonopore circular (Fig. 34J–K).

Female. Membrane of hemelytra not reaching the posterior margin of mediotergite VIII, apical margin convex; median portion of posterior margin of mediotergite VIII concave; median portion of posterior margin of urosternite VII subrectilinear; projections of urosternite VII as described for *I. scutellata* (Fig. 35C, mpr). **Genitalia.** Valvifers VIII wider than long, subtriangular; posterior margin subrectilinear and oblique to the median line; sutural margins subrectilinear, slightly convex distally and folded dorsally; surface dark yellowish with brown punctures; setae on the distal half of the sutural margins and median portion of the posterior margin; longitudinal grooves narrow and shallow close to the sutural margins (Figs. 5T; 35C, vf8). Valvifers IX partially covered by valvifers VIII, lateral margin subrectilinear, setae on mid-basal portion of ventral surface (Fig. 35C–D, vf9). Laterotergites IX not reaching the posterior margin of mediotergite VIII; lateral margin convex; setae on median portion of lateral margin and on mid-basal portion of ventral surface (Fig. 35C–D, la9). Thickening of vaginal intima triangular, distal corner larger than the proximal two; extensive triangular and membranous median area (Fig. 35D, vi). Vesicular area anterior to the collar 1/8 of the posterior one; median duct anterior to the collar with slight proximal widening (Fig. 35D, mdp); median duct posterior to the collar with proximal and distal widening (Fig. 35D, md); inner duct coiled in the proximal widening (Fig. 35D, id). Distal ductus receptaculi of same caliber as the proximal (Fig. 35D, drd, drp). Pars intermedialis subcylindrical, slightly wider distally (Fig. 35D, pi); proximal annular crest about half the diameter of the distal one (Fig. 35D, dac, pac). Capsula seminalis conical, with a long laterobasal projection directed to the pars intermedialis (Fig. 35D, cs, pr).

Measurements: Table 15.

Distribution. Bolivia (La Paz, Santa Cruz), Argentina (Salta, Jujuy, Tucumán, Santiago del Estero, Córdoba) (Fig. 8).

Comments. *Ischnopelta marginella* sp. n. distinguishes by the apex of the strongly emarginated, the apex of scutellum widely rounded, usually emarginated, the wide drop-shaped dark spots on the lateral of the urosternites (Figs. 34A–B; 35A–B), the male hexagonal segment X (Fig. 34L–M), and the female subtriangular valvifers VIII (Figs. 5T; 36C, vf8).

***Ischnopelta montana* Rosso & Campos, sp. n.** (Figs. 5R, 36–37)

Etymology. The epithet refers to the mountain habitats

of the specimens used in the description, collected in altitudes above 1,100m at the Caraça and Cipó Mountains, components of the geological province of Serra do Espinhaço, southeast of Minas Gerais state, Brazil. Latin: *montanus* = of mountains, belonging to the mountain.

Type Locality. BRAZIL, *Minas Gerais*, Catas Altas [-20.102777, -43.491666].

Holotype. Male. BRAZIL, *Minas Gerais*, Catas Altas, XI.1961, Kloss, Lenko, Martins & Silva. Deposited at Museu de Zoologia da Universidade de São Paulo (MZSP), São Paulo (SP), Brazil.

Paratypes. 3 males and 2 females. BRAZIL, *Minas Gerais*, Santana do Riacho, Serra do Cipó district (old Cardeal Mota district), (20 km NE, Rod. MG 10, km 114), 1 female, 6.XI.1997, T.J. Henry & A. Paula, [-19.280555, -43.549444], (USNM); Catas Altas (Caraça, Serra do Caraça), 3 males and 1 female 23–26.XI.1960, U.R. Martins, [-20.102777, -43.491666], (MZSP).

Description. The overall somatic morphology is as described for *I. scutellata*, except for the following features. Body densely punctured, brownish. Head. Setae on mid-apical region of ventral surface of mandibular plates longer than in most species. Bucculae slightly higher than the first labial segment. Labrum inserted posteriorly to half the distance between the anterior margin of the eyes and apex of mandibular plates. Antennae: segment I dark yellowish with brown blotches; segments II and III brown ventrally and dark yellowish dorsally, distal half of segment II and segment III densely punctured; segments IV and V dark brown; segments ratio: I≥II<III<IV<V.

Thorax. Hemelytra: corium as long as scutellum; conspicuous spot at apex of radial vein. Pro- and mesosternum punctured. Pro-, meso- and metapleura dark yellowish. Setae on posterodorsal margin of protibiae as long as the others.

Abdomen. Dark spots at the lateral of urosternites narrow and subtriangular, the anterior than the posterior.

Male. Apical margin of membrane of hemelytra convex; median portion of posterior margin of urosternite VII concave; urosternite VII not reaching anteriorly the imaginary line connecting the spiracles of urosternite V. **Genitalia.** Pygophore with dorsal rim slightly concave (Fig. 36C, dr) and ventral rim sinuous (Fig. 36D, vr). Posterolateral angles 0.9 times smaller than the rest of the pygophore, perpendicular to the frontal plane, divergent from the base, apices sharply rounded (Fig. 36C–E, pla). Setae short and sparse on distal half of ventral and lateral surfaces of the pygophore; setae long and dense on the ventral rim and ventral and apical margins of the posterolateral angles. Segment X as long as wide, surpassing the apex of posterolateral angles, but not the parameres; rounded; dorsal surface sclerotized, membranous on the apical margin and small mid-basal area; covered by setae, longer and denser on the laterobasal margins (Figs. 36C–E, X; 36L–M). Parameres elongated, slightly swollen, longer than posterolateral angles; head subtriangular oblique to the frontal plane; outer and inner margins sinuous; distal half of inner margin with median excavation and more sclerotized; apices narrow and

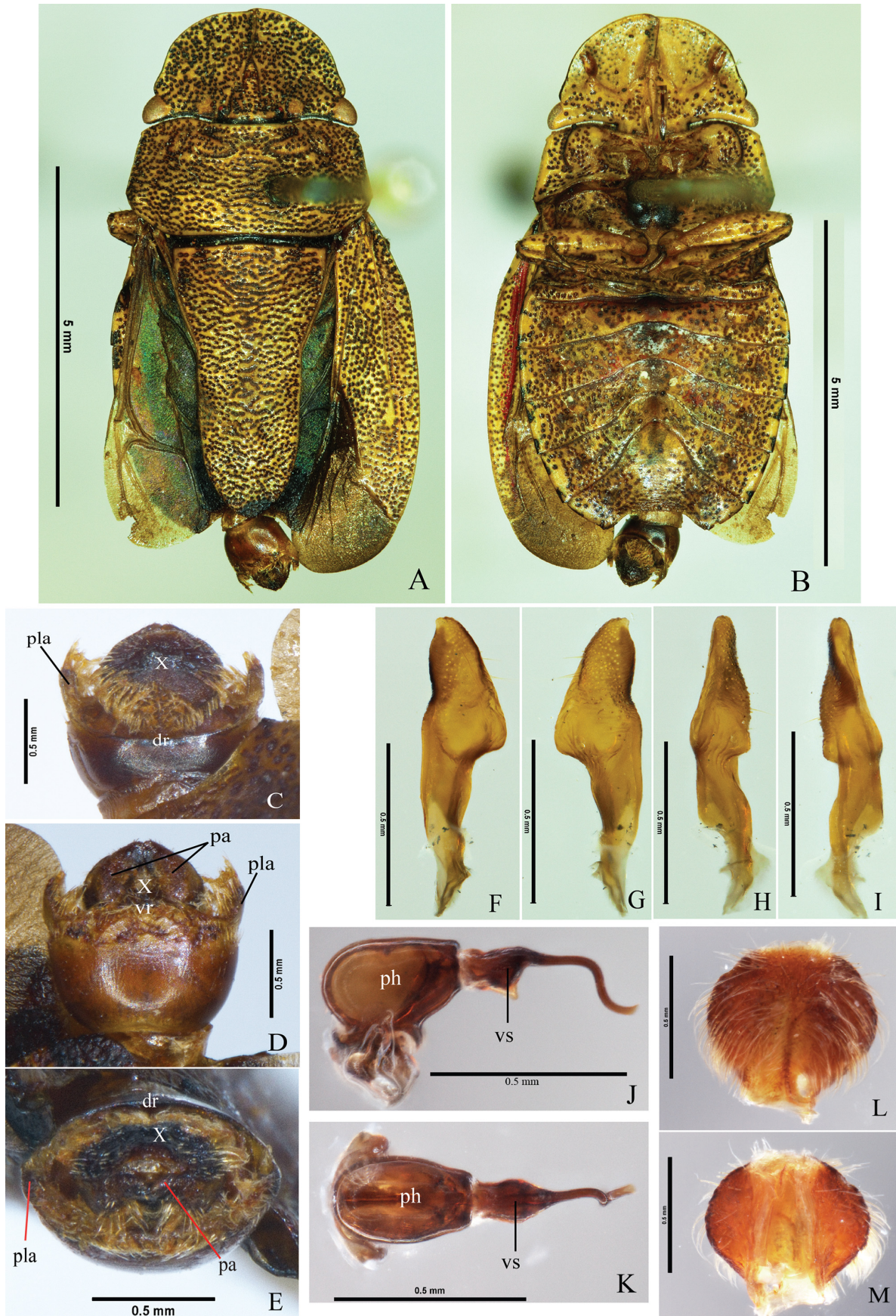

FIGURE 36. *Ischnopelta montana* Rosso & Campos, sp. n. Holotype male. A, dorsal view; B, ventral view; C–E, pygophore: dorsal, ventral, and posterior views respectively; F–I, parameters: dorsal, ventral, external and internal lateral views, respectively; J–K, phallus: lateral and dorsal views, respectively; L–M, segment X, dorsal and ventral views, respectively. Abbreviations: dr, dorsal rim; pa, parameter; ph, phalloteca; pla, posterolateral angle; vr, ventral rim; vs, vesica; X, segment X.

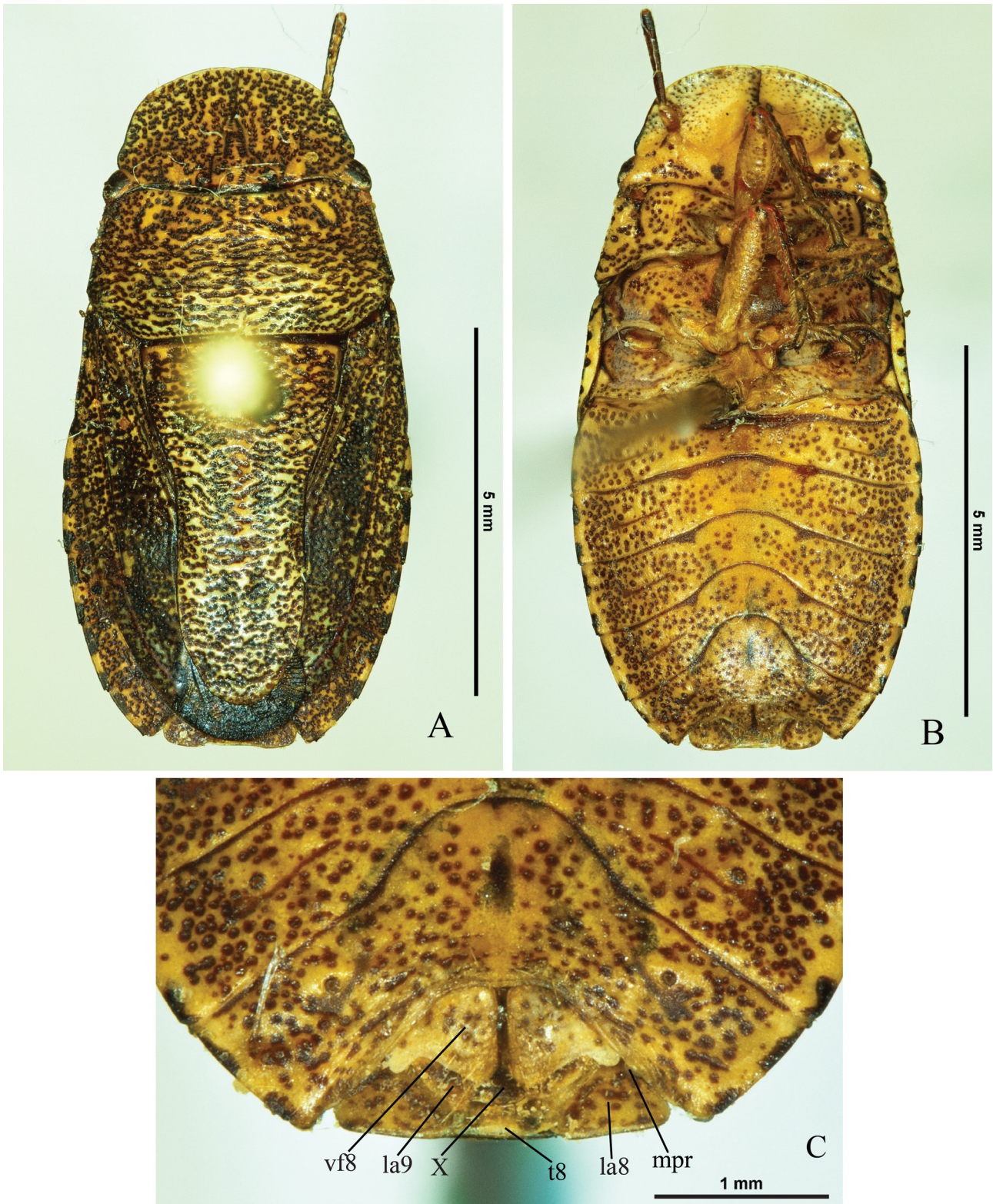

FIGURE 37. *Ischnopelta montana* Rosso & Campos, sp. n. Female. A, dorsal view; B, ventral view; C, genital plates ventroposterior view (45°). Abbreviations: la8, laterotergite 8; la9, laterotergite 9; mpr, projection on the lateral third of posterior margin of sternite VII; t8, mediotergite VIII; vf8, valvifer 8; X, segment X.

TABLE 16. Measurements (mean, standard deviation, minimum and maximum) and number of *Ischnopelta montana* Rosso & Campos, sp. n. specimens evaluated (n).

Body structure	Measurements performed	Male		Female	
		n	Measurements (mm)	n	Measurements (mm)
Body	tl	3	7.53±0.09; (7.47–7.63)	2	9.22±0.37; (8.95–9.48)
	mw		4.01±0.06; (3.95–4.06)		4.85±0.03; (4.83–4.87)
Head	hl		1.86±0.06; (1.78–1.96)		1.96±0.09; (1.89–2.02)
	cl		0.52±0.04; (0.46–0.58)		0.60±0.00; (0.60–0.60)
	hw	5	3.20±0.11; (3.07–3.38)	2	3.62±0.17; (3.50–3.74)
	iod		0.89±0.04; (0.83–0.94)		0.99±0.01; (0.99–0.99)
	ied		2.55±0.08; (2.47–2.67)		2.88±0.18; (2.75–3.00)
	pl		1.58±0.09; (1.50–1.73)		1.86±0.18; (1.74–1.99)
Pronotum	haw	5	3.69±0.26; (3.49–4.13)	2	4.12±0.19; (3.98–4.25)
	aaw		3.22±0.19; (3.08–3.53)		3.53±0.20; (3.39–3.67)
	sl	4	4.24±0.30; (4.01–4.68)		4.95±0.28; (4.75–5.15)
Scutellum	fl	5	1.70±0.06; (1.65–1.77)		1.93±0.13; (1.84–2.02)
	pfl		2.54±0.28; (2.36–2.94)	2	3.02±0.16; (2.91–3.13)
	bsw	4	2.34±0.16; (2.20–2.62)		2.64±0.16; (2.53–2.75)
	fcw		1.58±0.19; (1.46–1.87)		1.82±0.06; (1.78–1.86)
	I		0.47±0.03; (0.43–0.50)		0.48±0.02; (0.47–0.50)
Antennae	II	3	0.43±0.03; (0.40–0.47)	2	0.47±0.00; (0.47–0.47)
	III		0.71±0.00; (0.71–0.71)		0.81±0.09; (0.74–0.87)
	IV		0.81±0.03; (0.78–0.84)	0	–
	V	2	1.15±0.04; (1.12–1.18)		–
	I		0.56±0.01; (0.56–0.59)		0.64±0.02; (0.62–0.65)
Labium	II	5	1.33±0.03; (1.30–1.36)	2	1.38±0.02; (1.36–1.40)
	III		0.53±0.00; (0.53–0.53)		0.56±0.00; (0.56–0.56)
	IV		0.33±0.01; (0.31–0.34)		0.39±0.02; (0.37–0.40)

Legend: tl, total length; mw, maximum width (at the sternite III level); hl, head length; cl, clypeus length; hw, head width; iod, interocellar distance; ied, interocular distance; pl, pronotum length; haw, pronotum width at the level of humeral angles; aaw, pronotum width at the level of anterolateral angles; sl, scutellum length; fl, frenal lobe length; pfl, post-frenal lobe length; bsw, basal scutellum width; fcw, scutellum width at the level of frenal constriction; I, II, III, IV and V, antennal and labium segments length.

convergent (Figs. 36D–E, pa; 36F–I). Cup-like sclerites visible, apices narrow and convergent. Phallus: proximal portion of vesica biconvex laterally, dorsal surface flat and slightly depressed, ventral surface expanded and with minute ventroposterior process; median portion cylindrical, posteriorly directed; distal portion sinuous, ventroposteriorly directed; secondary gonopore beveled (Fig. 36J–K).

Female. Membrane of hemelytra not reaching the posterior margin of mediotergite VIII, posterior margin convex; median portion of posterior margin of mediotergite VIII and of urosternite VII subrectilinear; projections of urosternite VII thick and perpendicular to the surface, folded beneath the urosternite. **Genitalia.** Valvifers VIII wider than long; posterior margin sinuous, lateral angles round and projected; sutural angles narrowly rounded; sutural margins subrectilinear and folded dorsally; surface longitudinally convex, dark yellowish with brown

punctures, setae on the median portion of posterior margin (Figs. 5R; 37C, vf8). Valvifers IX covered by valvifers VIII. Laterotergites IX not reaching the posterior margin of mediotergite VIII, largely covered by valvifers VIII (Fig. 37C, la9); lateral margin of visible portion convex. Internal genitalia not examined.

Measurements: Table 16.

Distribution. Brazil (Minas Gerais) (Fig. 8).

Comments. See comments in *I. cordiformis* sp. n.. The material available for the description of *Ischnopelta montana* sp. n. is greatly damaged. As in *I. cylindrata* sp. n. (Fig. 26A–B), the setae of the mid-apical band of ventral surface of the mandibular plates are about three times longer than those observed in the other species.

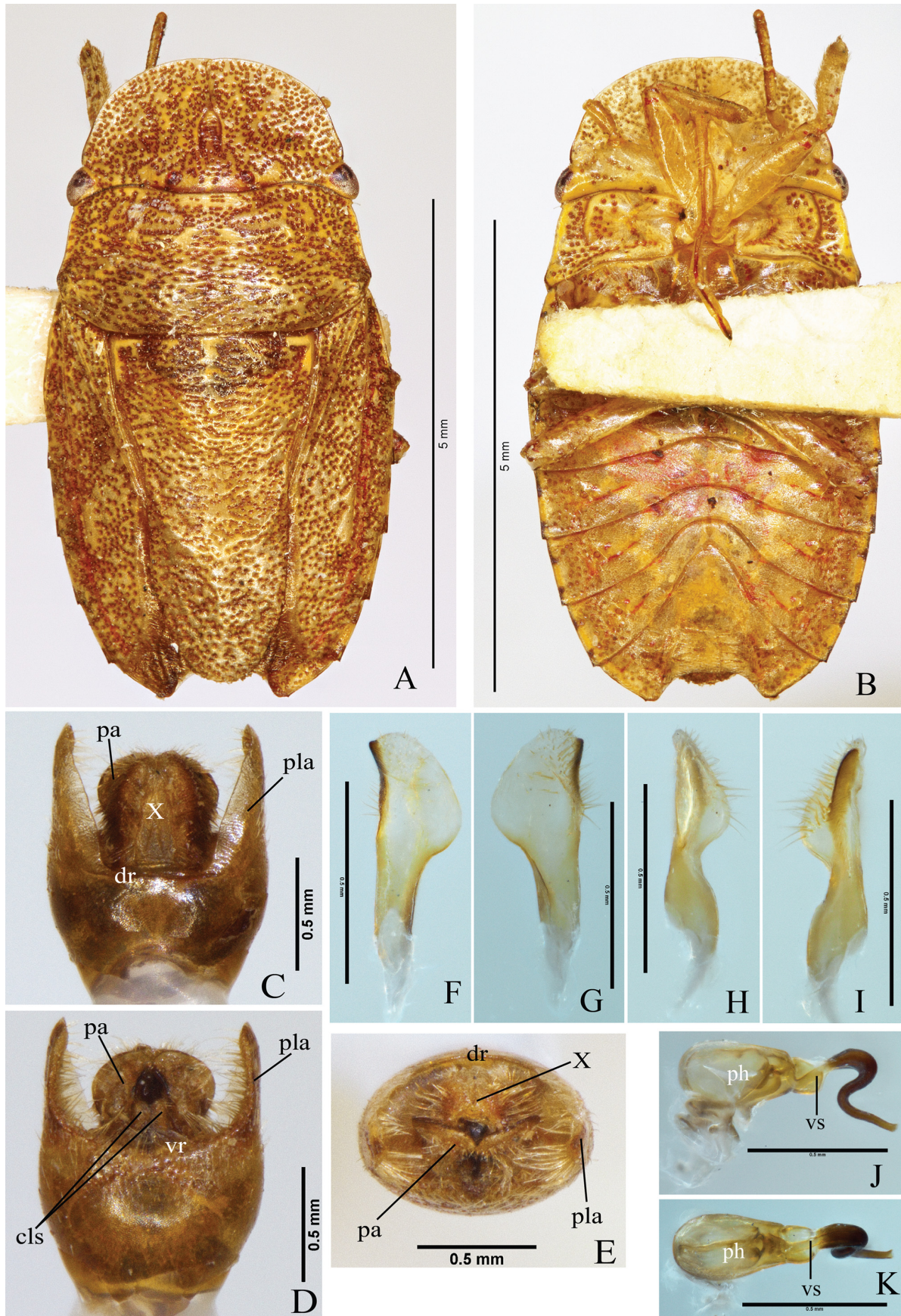

FIGURE 38. *Ischnopelta paiagua* Rosso & Campos, sp. n. Holotype male. A, dorsal view; B, ventral view; C–E, pygophore: dorsal, ventral, and posterior views respectively; F–I, parameters: dorsal, ventral, external and internal lateral views, respectively; J–K, phallus: lateral and dorsal views, respectively. Abbreviations: cls, cup like sclerites; dr, dorsal rim; pa, parameter; ph, phalloteca; pla, posterolateral angle; vr, ventral rim; vs, vesica; X, segment X.

Ischnopelta paiagua Rosso & Campos, sp. n. (Fig. 38)

Etymology. The epithet is in honor to the native people Paiaguás, currently extinct, that originally inhabited the Pantanal region in Brazil, where the species is distributed.

Type Locality. BRAZIL, *Mato Grosso do Sul*, Corumbá [-19.0167, -57.6500].

Holotype. Male. BRAZIL, *Mato Grosso do Sul*, Corumbá, 1950, H.G. Barber Coll. Deposited at Museu de Zoologia da Universidade de São Paulo (MZSP), São Paulo (SP), Brazil.

Paratypes. 1 male. BRAZIL, *Mato Grosso*, Cáceres, 1 male, XII.1955, M. Alvarenga, [-16.0667, -57.6833], (MNRJ).

Description. The overall somatic morphology is as described for *I. scutellata*, except for the following features. Head. Labrum inserted anteriorly to half the distance between the anterior margin of the eyes and the apex of mandibular plates. Antennae: segment I

dark yellowish with brown blotches; segments II and III dark yellowish, slightly darker ventrally, punctures on segment III; segments IV and V brown, segments ratio: I>II<III<IV<V.

Thorax. Hemelytra: conspicuous spot at apex of the radial vein. Pro-, meso- and metasternum dark yellowish.

Abdomen. Dark spots at the lateral of urosternites narrow, subequal in length.

Male. Apical margin of membrane of hemelytra convex; median portion of posterior margin of urosternite VII subrectilinear; urosternite VII reaching anteriorly the imaginary line connecting the spiracles of urosternite V. **Genitalia.** Pygophore with dorsal and ventral rim slightly concave (Figs. 38C, dr; 38D, vr). Posterolateral angles 1.5 times longer than the rest of the pygophore, perpendicular to the frontal plane, subparallel, apices slightly convergent; basal portion of dorsal margin less sclerotized and folded into the pygophore (Fig. 38C–E, pla). Long setae on the ventral rim and ventral margin of the posterolateral angles, directed to the parameres.

TABLE 17. Measurements (mean, standard deviation, minimum and maximum) and number of *Ischnopelta paiagua* Rosso & Campos. sp. n. specimens evaluated (n).

Body structure	Measurements performed	Male		Female	
		n	Measurements (mm)	n	Measurements (mm)
Body	tl	2	7.12±0.22 (6.97–7.27)	–	–
	mw		3.84±0.09 (3.78–3.90)		–
Head	hl		1.62±0.15 (1.51–1.73)		–
	cl		0.55±0.06 (0.50–0.59)		–
	hw	2	3.22±0.08 (3.16–3.28)	–	–
	iod		0.89±0.05 (0.85–0.92)		–
	ied		2.63±0.06 (2.58–2.67)		–
Pronotum	pl		1.55±0.05 (1.52–1.59)		–
	haw	2	3.47±0.12 (3.39–3.56)	–	–
	aaw		3.08±0.08 (3.02–3.14)		–
Scutellum	sl		3.88±0.01 (3.87–3.88)		–
	fl		1.53±0.01 (1.52–1.53)		–
	pfl	2	2.35±0.02 (2.34–2.36)	–	–
	bsw		2.29±0.08 (2.23–2.34)		–
	fcw		1.54±0.03 (1.52–1.56)		–
Antennae	I		0.47±0.01 (0.46–0.47)		–
	II	2	0.41±0.01 (0.41–0.42)		–
	III		0.70±0.02 (0.68–0.71)	–	–
	IV		0.78		–
	V	1	0.99		–
Labium	I		0.59±0.04 (0.56–0.61)		–
	II	2	1.25±0.03 (1.22–1.27)	–	–
	III		0.50±0.01 (0.49–0.51)		–
	IV		0.31±0.04 (0.29–0.34)		–

Legend: tl. total length; mw. maximum width (at the sternite III level); hl. head length; cl. clypeus length; hw. head width; iod. interocellar distance; ied. interocular distance; pl. pronotum length; haw. pronotum width at the level of humeral angles; aaw. pronotum width at the level of anterolateral angles; sl. scutellum length; fl. frenal lobe length; pfl. post-frenal lobe length; bsw. basal scutellum width; fcw. scutellum width at the level of frenal constriction; I. II. III. IV and V. antennal and labium segments length.

Segment X longer than wide, not reaching the apex of the posterolateral angles and parameres; oval; apical margin weakly emarginated, lateral margins sclerotized and covered by dense, long setae; mid-longitudinal surface membranous with short and sparse setae (Fig. 38C and E, X). Parameres claviform, head slightly swollen, oblique to the frontal plane; outer margin sinuous, apical portion strongly convex; inner margin sinuous, apical portion more sclerotized and slightly convergent; apical margin narrow and convex; ventral surface sinuous, setae covering a band on the sclerotized area of the inner margin up to the apical margin (Figs. 38D, pa; 38F–I). Cup-like sclerites externally visible, apices rounded and subparallel (Fig. 38D, cls). Phallus: vesica sharply sinuous; proximal portion short, widened laterally, flat dorsally and expanded ventrally, weakly sclerotized and translucent in some points; median portion flat, more sclerotized than proximal portion, narrowing gradually; distal portion subcylindrical and gradually narrowing; secondary gonopore beveled (Fig. 38J–K).

Female. Unknown.

Measurements: Table 17

Distribution. Brazil (Mato Grosso, Mato Grosso do Sul) (Fig. 8).

Comments. See comments in *I. guarani* sp. n..

***Ischnopelta parvula* Rosso & Campos, sp. n.** (Figs. 5L, 39–40)

Etymology. The epithet refers to the small size of the two lateral brown spots on each abdominal segment. Latin: *parvulus* (dim.) = small, minute.

Type Locality. BRAZIL, *Bahia*, Itabuna [-4.7865, -39.2728].

Holotype. Male. BRAZIL, *Bahia*, Itabuna, G. Bondar. Deposited at Museu de Zoologia da Universidade de São Paulo (MZSP), São Paulo (SP), Brazil.

Paratypes. 1 male and 2 females. BRAZIL, *Paraíba*, Areias, 1 male, IV.1933, [-6.9691, -35.7015], (MNRJ); *Bahia*, Itabuna, 2 females, G. Bondar, [-4.7865, -39.2728], (MNRJ).

Description. The overall somatic morphology is as described for *I. scutellata*, except for the following features. Head. Labrum inserted anteriorly to half the distance between the anterior margin of the eyes and apex of mandibular plates. Antennae dark yellowish with rare and minute punctures on segments II and III; segments ratio: I=II<III<IV<V.

Thorax. Hemelytra: corium as long as scutellum; conspicuous spot at apex of the radial vein. Pro-, meso- and metasternum dark yellowish. Pro-, meso- and metapleura dark yellowish, densely punctured on the laterals. Evaporatorium not reaching the lateral margin of mesopleura. Setae on posterodorsal margin of protibiae as long as the others.

Abdomen. Dark spots at the lateral of urosternites minute; urosternite VII unarmed.

Male. Apical margin of membrane of hemelytra subrectilinear. Median portion of posterior margin of

urosternite VII concave; urosternite VII not reaching anteriorly the imaginary line connecting the spiracles of urosternite V. **Genitalia.** Pygophore with dorsal rim concave and median region more sclerotized (Fig. 39C, dr); ventral rim subrectilinear with wide and shallow median depression (Fig. 39D, vr). Posterolateral angles 1.5 times longer than the rest of the pygophore, base perpendicular and apex oblique to the frontal plane, convergent from the base (Fig. 39C–E, pla). Setae short and sparse on posterior half of ventral and lateral surfaces of the pygophore, and on outer surface of the posterolateral angles; 1 + 1 tufts of long setae lateral to the median depression of ventral rim. Segment X as wide as long, reaching the apex of posterolateral angles and surpassing the apex of parameres; rounded; basal area and apical margin membranous; disc sclerotized and covered by setae (Fig. 39C–E, X). Parameres falciform, flat, shorter than posterolateral angles; subparallel to the frontal plane; apical portion of outer margin strongly convex; inner margin sinuous, distal portion strongly excavated and with an apical process, aculeiform, convergent, and ventrolaterally directed; apical margin convex; ventral surface with oblique crest (Fig. 39D, vcp) and setae posterior to the crest (Fig. 39D–E, pa). Cup-like sclerites externally visible, with apices convergent (Fig. 39D, cls). Internal genitalia not examined.

Female. Membrane of hemelytra not reaching the posterior margin of mediotergite VIII, posterior margin convex; median portion of posterior margin of mediotergite VIII and of urosternite VII, and projections of urosternite VII as described for *I. scutellata* (Fig. 40C, mpr). **Genitalia.** Valvifers VIII wider than long; posterior margin slightly sinuous, with small projection on the lateral angle; sutural margins subrectilinear and folded dorsally; surface dark yellowish with punctures and brown blotches; setae on distal portion of sutural margins and median portion of posterior margin (Figs. 5L; 40C, vf8). Valvifers IX with apices externally visible, lateral margin convex, setae on mid-basal portion of ventral surface (Fig. 40C–D, vf9). Laterotergites IX not reaching the posterior margin of mediotergite VIII; lateral margin convex; setae on mid-basal portion of lateral margin and ventral surface (Fig. 40C–D, la9). Thickening of vaginal intima cordiform, wider than long; distal margin concave and more sclerotized; lateral margins convex; mid-basal subquadrangular area membranous (Fig. 40D, vi). Vesicular area anterior to the collar 1/10 the posterior portion; median duct anterior to the collar with slight proximal widening (Fig. 40D, md); inner duct not coiled (Fig. 40D, id). Distal ductus receptaculi of same caliber as the proximal one (Fig. 40D, drd, drp). Pars intermedialis cylindrical (Fig. 40D, pi); proximal annular crest perpendicular to the pars intermedialis, distal annular crest directed to the pars intermedialis and twice the size of the proximal (Fig. 40D, dac, pac). Capsula seminalis globose, with two lateral filiform projections directed to the pars intermedialis, one long surpassing the proximal annular crest and the other reaching the distal annular crest (Fig. 40D, cs, pr).

Measurements: Table 18.

Distribution. Brazil (Paraíba, Bahia) (Fig. 8).

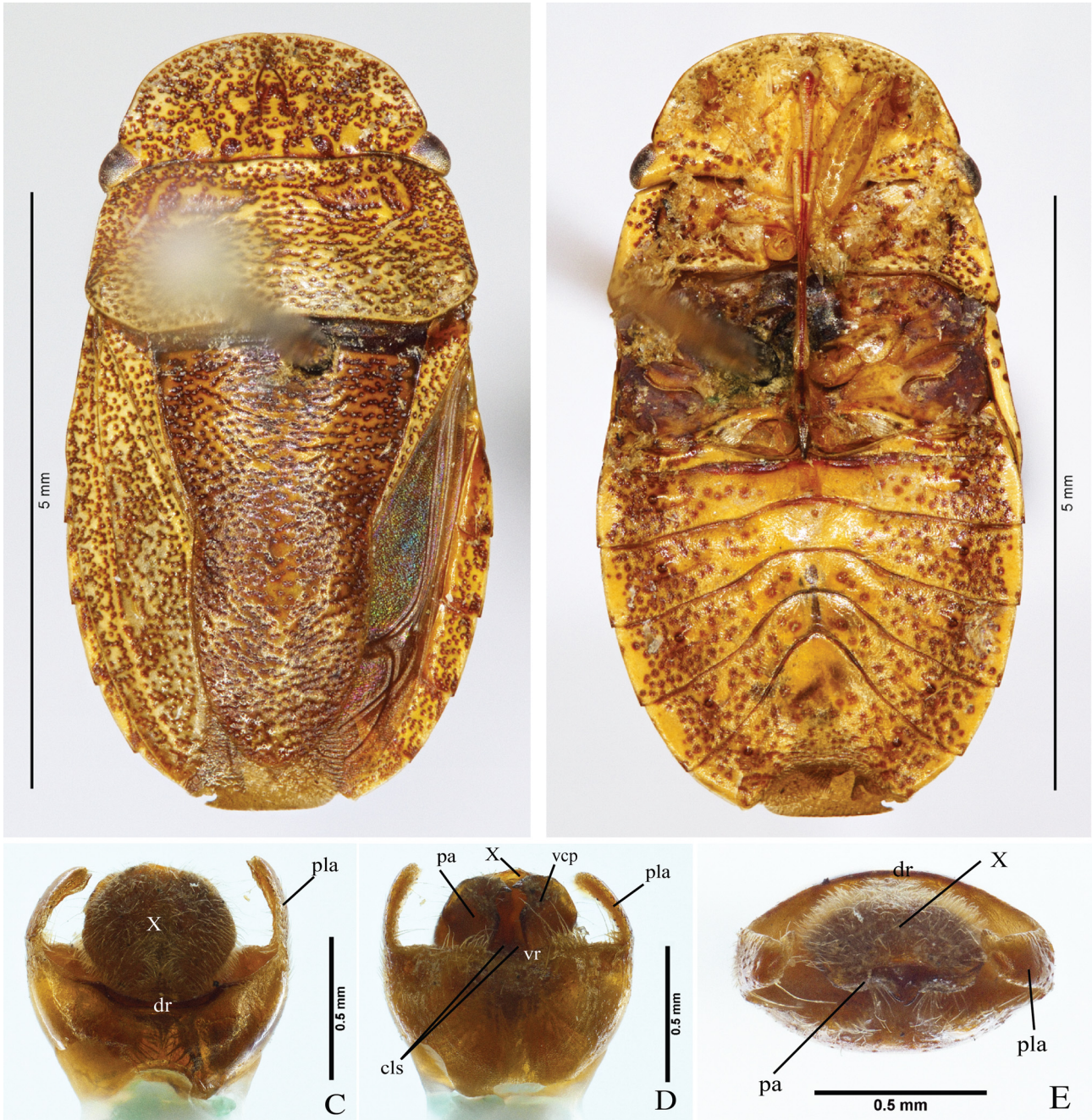

FIGURE 39. *Ischnopelta parvula* Rosso & Campos, sp. n. Holotype male. A, dorsal view; B, ventral view; C–E, pygophore: dorsal, ventral, and posterior views, respectively. Abbreviations: cls, cup like sclerites; dr, dorsal rim; pa, parameter; pla, posterolateral angle; vcp, ventral crest; vr, ventral rim; X, segment X.

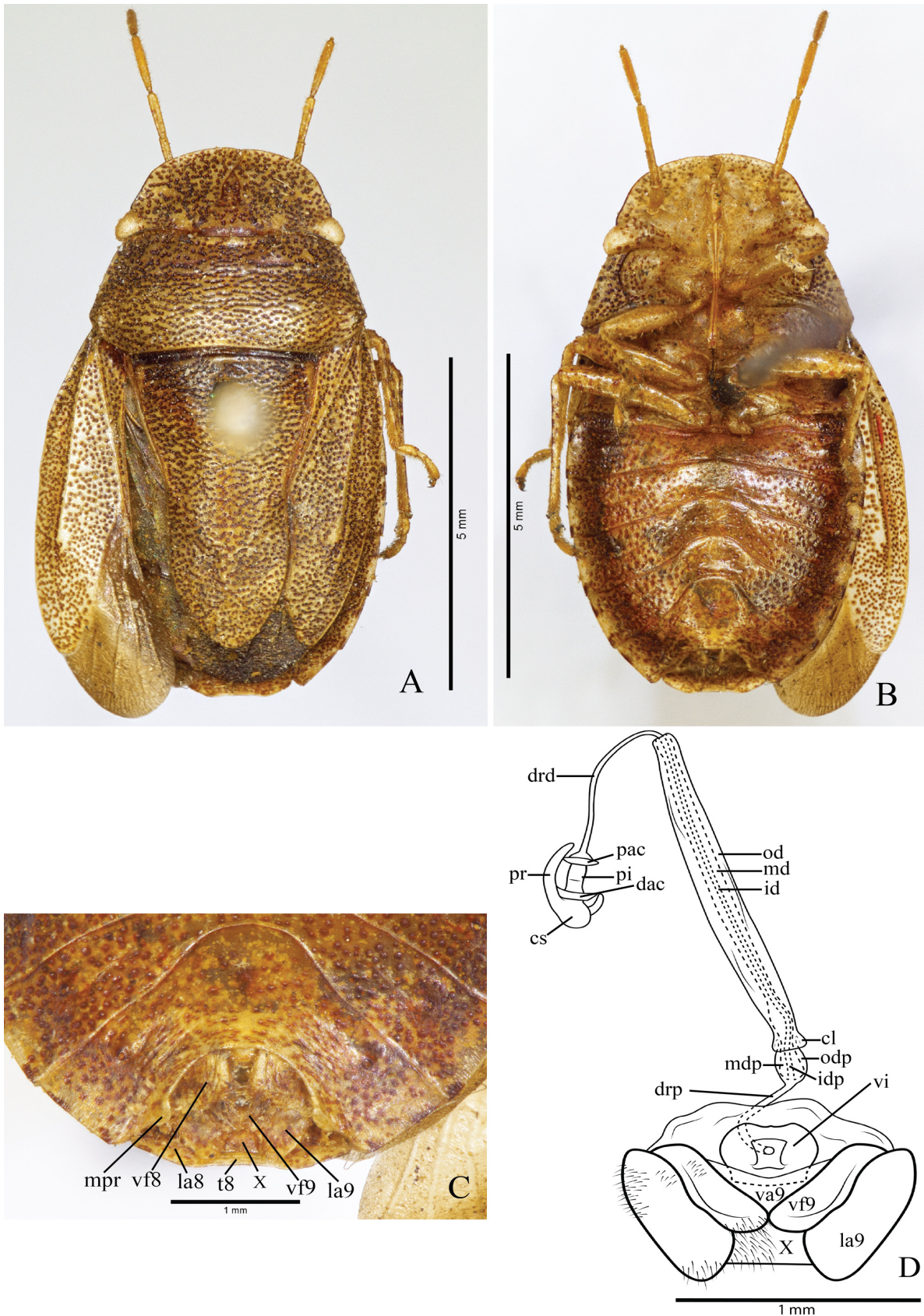

FIGURE 40. *Ischnopelta parvula* Rosso & Campos, sp. n. Female. A, dorsal view; B, ventral view; C, genital plates ventroposterior view (45°); D, internal genitalia. Abbreviations: cl, collar; cs, seminalis capsula; dac, distal annular crest; drd, distal ductus receptaculi; drp, proximal ductus receptaculi; id, internal duct; idp, proximal internal duct; la8, laterotergite VIII; la9, laterotergite IX; md, medium duct; mdp, proximal medium duct; mpr, projection on the lateral third of posterior margin of sternite VII; od, external duct; odp, proximal external duct; pac, proximal annular crest; pi, pars intermedialis; pr, projection; t8, mediotergite VIII; va9, valvulae IX; vf8, valvifer VIII; vf9, valvifer IX; vi, thickening of vaginal intima; X, segment X.

TABLE 18. Measurements (mean, standard deviation, minimum and maximum) and number of *Ischnopelta parvula* Rosso & Campos, sp. n. specimens evaluated (n).

Body structure	Measurements performed	Male		Female	
		n	Measurements (mm)	n	Measurements (mm)
Body	tl	2	6.70±0.05; (6.67–6.73)	2	8.38±0.08; (8.32–8.44)
	mw		3.75±0.18; (3.63–3.88)		4.46±0.32; (4.23–4.68)
Head	hl		1.46±0.01; (1.45–1.46)		1.65±0.02; (1.63–1.67)
	cl		0.50±0.02; (0.48–0.51)		0.61±0.04; (0.58–0.65)
	hw	2	3.01±0.03; (3.00–3.03)	3	3.36±0.12; (3.27–3.50)
	iod		0.82±0.01; (0.81–0.82)		0.93±0.02; (0.92–0.95)
	ied		2.40±0.04; (2.37–2.42)		2.68±0.09; (2.60–2.78)
	pl		1.50±0.03; (1.48–1.52)		1.73±0.05; (1.70–1.78)
Pronotum	haw	2	3.43±0.04; (3.40–3.46)	3	4.08±0.15; (3.99–4.25)
	aaw		2.91±0.03; (2.89–2.92)		3.32±0.07; (3.25–3.40)
	sl		3.67±0.04; (3.64–3.70)		4.35±0.16; (4.19–4.51)
Scutellum	fll		1.48±0.10; (1.41–1.55)		1.80±0.18; (1.69–2.01)
	pfl	2	2.19±0.14; (2.10–2.29)	3	2.55±0.08; (2.50–2.63)
	bsw		2.23±0.01; (2.22–2.24)		2.65±0.15; (2.52–2.81)
	fcw		1.51±0.06; (1.47–1.55)		1.77±0.05; (1.74–1.83)
	I		0.40		0.48±0.02; (0.47–0.50)
Antennae	II		0.40		0.51±0.02; (0.50–0.53)
	III	1	0.72	2	0.81±0.09; (0.74–0.87)
	IV		0.97		0.99±0.00; (0.99–0.99)
	V	0	–		1.21±0.00; (1.21–1.21)
	I		0.61±0.00; (0.61–0.61)		0.61
Labium	II	2	1.24±0.13; (1.15–1.33)	1	1.37
	III		0.52±0.03; (0.50–0.54)		0.54
	IV		0.38±0.03; (0.36–0.40)		0.40

Legend: tl, total length; mw, maximum width (at the sternite III level); hl, head length; cl, clypeus length; hw, head width; iod, interocellar distance; ied, interocular distance; pl, pronotum length; haw, pronotum width at the level of humeral angles; aaw, pronotum width at the level of anterolateral angles; sl, scutellum length; fll, frenal lobe length; pfl, post-frenal lobe length; bsw, basal scutellum width; fcw, scutellum width at the level of frenal constriction; I, II, III, IV and V, antennal and labium segments length.

Comments. See comments in *I. coralinae* sp. n. *Ischnopelta parvula* sp. n. presents minute spots on the laterals of the urosternites (Figs. 39B; 40B), the smallest among all the species in the genus.

***Ischnopelta pellucidula* Rosso & Campos, sp. n.** (Figs. 3, 5K, 41–43)

Etymology. Epithet proposed by Dr. H. Ruckes as registered in the manuscripts found with the specimens used in the study. He considered this species to have a semi-translucent aspect, from which the epithet is inferred. Latin: *pellucidus* = transparent + *ula* = diminutive.

Type Locality. BRAZIL, *Roraima*, Normandia [3.76952, -59.67135].

Holotype. Male. BRAZIL, *Roraima*, Normandia (Rio

Ireng/Maú), 16.VIII.1911. Deposited at Museu Paraense Emilio Goeldi (MPEG), Belém (PA), Brazil.

Paratypes. 10 males and 13 females. VENEZUELA, *Bolívar*, Ciudad Bolívar (35 km SWP for Ruta 2), 1 female, 13.VII–2.VIII.1987, S. & J. Peck, [8.122222, -63.549722], (AMNH); San Francisco, 8 males and 7 females, 22–26.X.1966, J. & B. Bechyné & E. Osuna, [7.0667, -63.6], (MIZA); Chirima, 1 female, 12.X.1966, J. & B. Bechyné & E. Osuna, [5.05, -60.95], (MIZA); BRAZIL, *Roraima*, Normandia (Rio Ireng/Maú), 2 males and 4 females, 16.VIII.1911, [3.76952, -59.67135], (UFRG).

Description. The overall somatic morphology is as described for *I. scutellata*, except for the following features. Two color morphs: the specimens from Roraima, Brazil, have low-contrasting punctures giving to the cuticle a light brown appearance (Figs. 41A–B and 42A–B); the specimens from Bolívar, Venezuela, high-

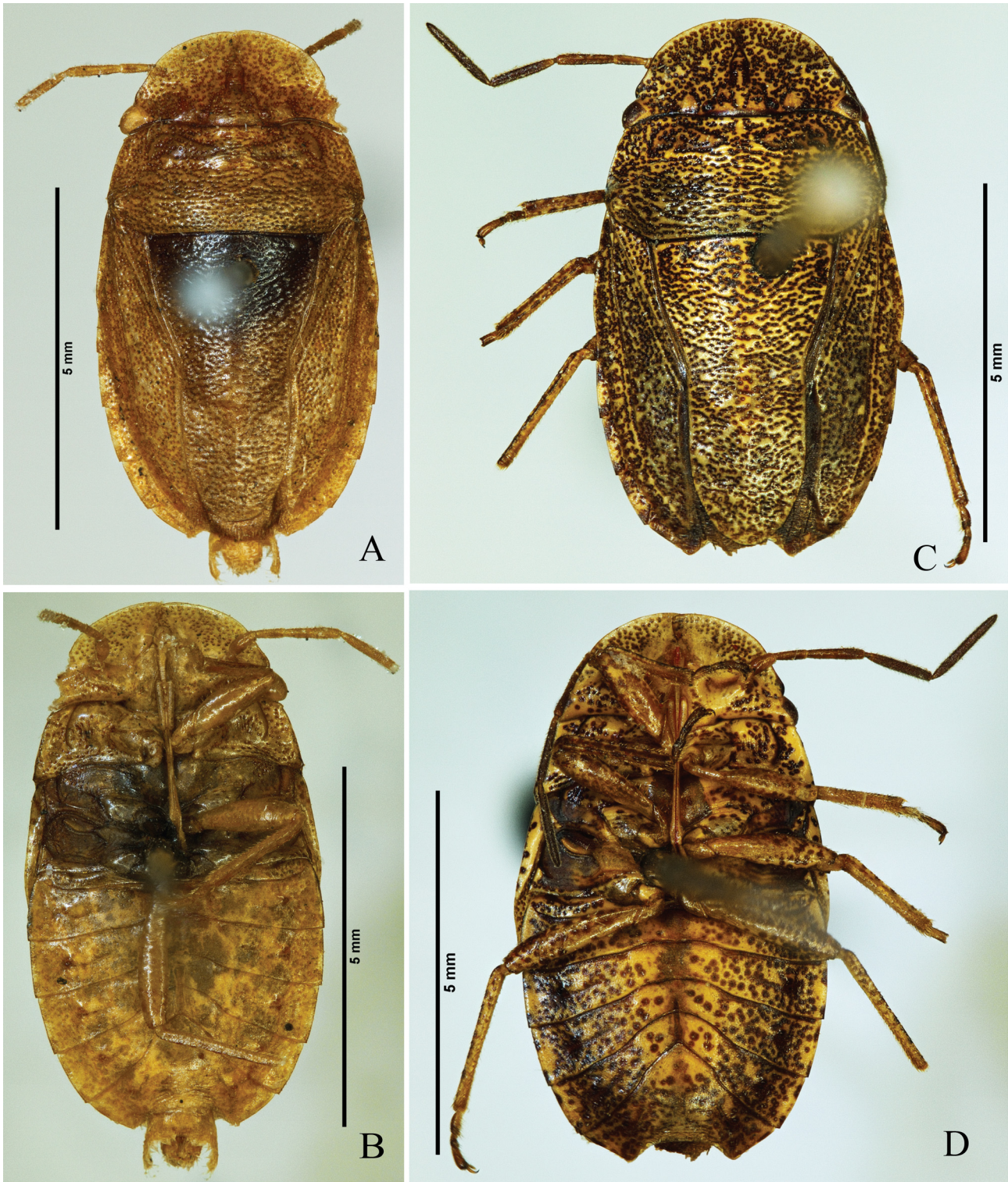

FIGURE 41. *Ischnopelta pellucidula* Rosso & Campos, sp. n. Holotype male (specimen from Rio Ireng, Roraima, Brazil) A, dorsal view; B, ventral view. Male (specimen from Department of Bolívar, Venezuela). C, dorsal view; D, ventral view.

contrasting, dark punctures giving to the cuticle a dark brown appearance (Figs. 41C–D and 42C–D). Head. Labrum inserted anteriorly to half the distance between the anterior margin of the eyes and apex of mandibular plates. Antennae: segments I to III dark yellowish, segments IV to V brown; segments ratio: $I \geq II < III < IV < V$.

Thorax. Hemelytra: corium as long as scutellum; spot at apex of the radial vein absent. Pro-, meso- and

metasternum dark yellowish and densely punctured. Evaporatorium not reaching the lateral margin of mesopleura. Setae on posterodorsal margin of protibiae as long as the others.

Abdomen. Dark spots at the lateral of urosternites narrow, subequal; urosternite VII unarmed.

Male. Apical margin of membrane of hemelytra convex; median portion of posterior margin of urosternite

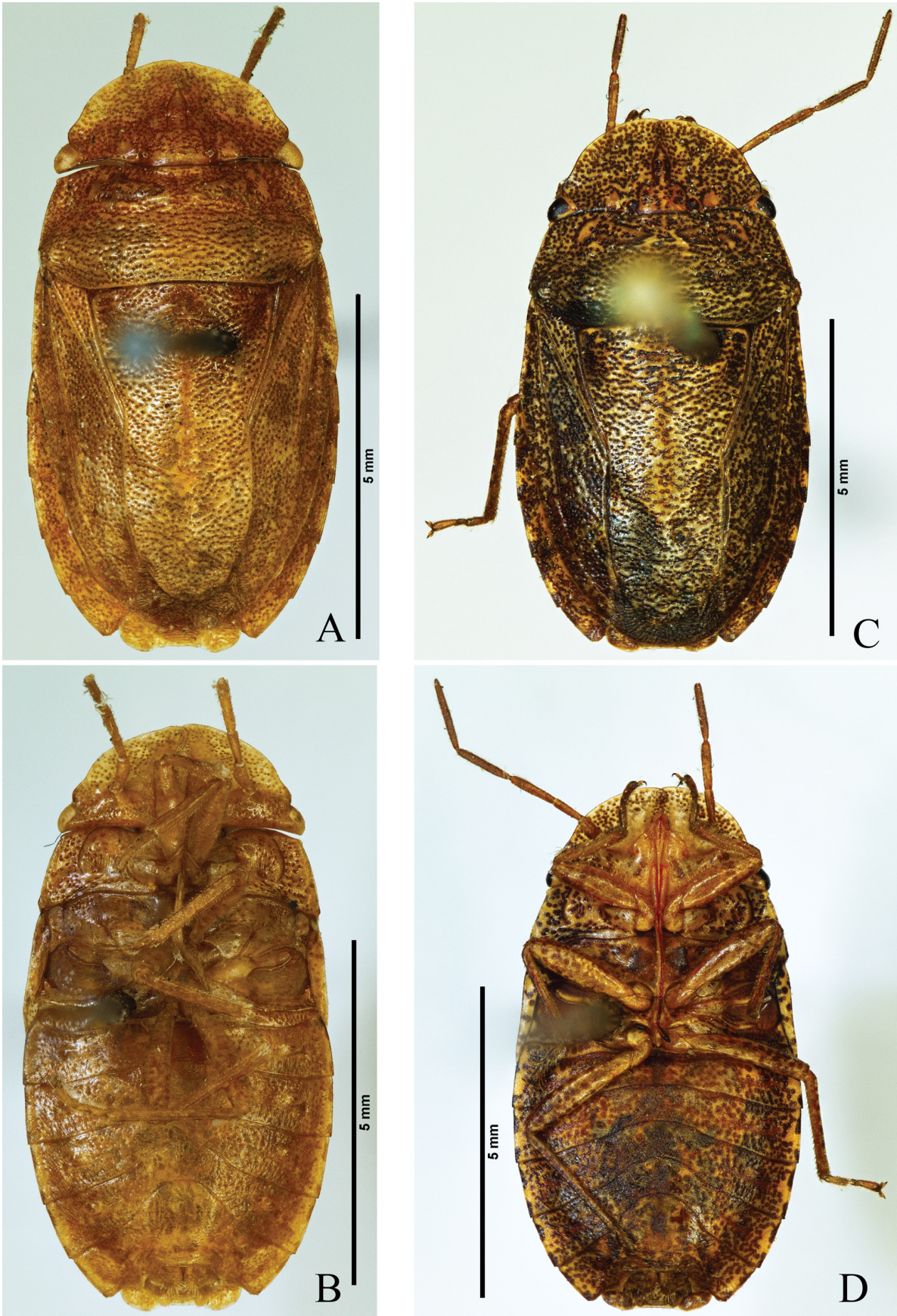

FIGURE 42. *Ischnopelta pellucidula* Rosso & Campos, sp. n. Female (specimen from Rio Ireng, Roraima, Brazil). A, dorsal view; B, ventral view. Female (specimen from Department of Bolívar, Venezuela). C, dorsal view; D, ventral view.

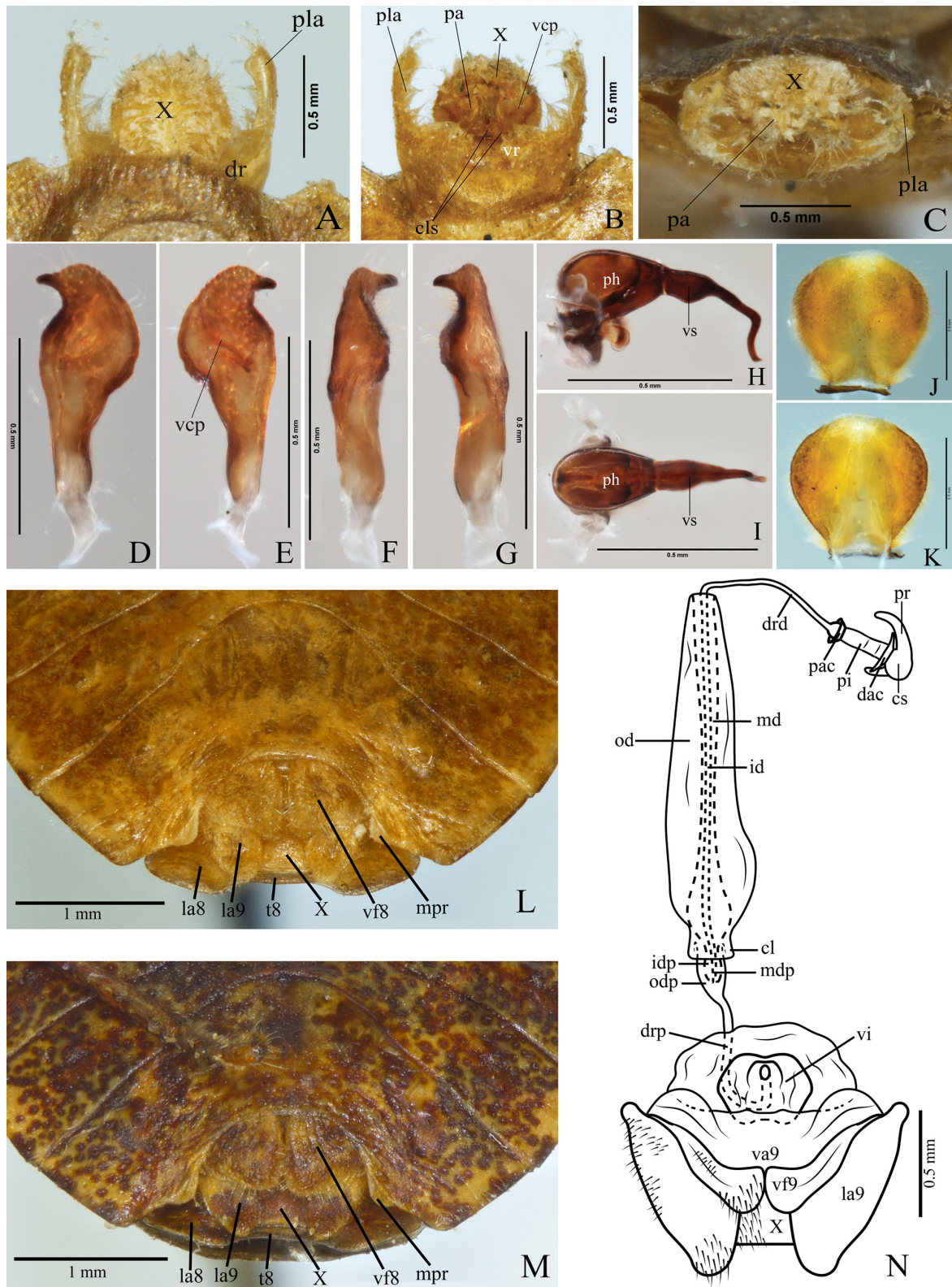

FIGURE 43. *Ischnopelta pellucidula* Rosso & Campos, sp. n. Male. A–C, pygophore: dorsal, ventral and posterior views respectively; D–G, parameters: dorsal, ventral, external and internal lateral views, respectively; H–I, phallus: lateral and dorsal views, respectively; J–K, segment X, dorsal and ventral views, respectively. Female. L–M, genital plates ventroposterior view (45°) of specimen from Rio Ireng, Roraima, Brazil and specimen from Department of Bolívar, Venezuela, respectively; N, internal genitalia. Abbreviations: cl, collar; cls, cup like sclerites; cs, seminalis capsule; dac, distal annular crest; dr, dorsal rim; drd, distal ductus receptaculi; drp, proximal ductus receptaculi; id, internal duct; idp, proximal internal duct; la8, laterotergite VIII; la9, laterotergite IX; md, medium duct; mdp, proximal medium duct; mpr, projection on the lateral third of posterior margin of sternite VII; od, external duct; odp, proximal external duct; pa, parameter; pac, proximal annular crest; ph, phalloteca; pi, pars intermedialis; pla, posterolateral angle; pr, projection; t8, mediotergite VIII; va9, valvulae IX; vcp, ventral crest; vf8, valvifer VIII; vf9, valvifer IX; vi, thickening of vaginal intima; vr, ventral rim; vs, vesica; X, segment X.

TABLE 19. Measurements (mean, standard deviation, minimum and maximum) and number of *Ischnopelta pellucidula* Rosso & Campos, sp. n. specimens evaluated (n).

Body structure	Measurements performed	Male		Female	
		n	Measurements (mm)	n	Measurements (mm)
Body	tl	11	7.52±0.13; (7.24–7.68)	11	8.53±0.26; (7.91–8.79)
	mw		4.21±0.17; (4.05–4.66)		4.66±0.13; (4.50–4.88)
Head	hl	11	1.64±0.06; (1.56–1.74)	13	1.72±0.07; (1.53–1.82)
	cl		0.58±0.03; (0.51–0.62)		0.65±0.04; (0.58–0.70)
	hw		3.30±0.06; (3.16–3.36)		3.59±0.11; (3.28–3.72)
	iod		0.93±0.07; (0.81–1.00)		1.03±0.03; (0.97–1.07)
	ied		2.66±0.09; (2.51–2.84)		2.89±0.11; (2.58–2.99)
	pl		1.64±0.05; (1.56–1.74)		1.81±0.06; (1.72–1.89)
Pronotum	haw	11	3.77±0.08; (3.62–3.92)	13	4.22±0.11; (4.03–4.40)
	aaw		3.24±0.09; (3.06–3.33)		3.58±0.10; (3.39–3.71)
	sl		4.29±0.12; (4.09–4.45)		4.84±0.15; (4.57–5.04)
Scutellum	fil	11	1.72±0.07; (1.59–1.86)	13	1.94±0.10; (1.77–2.18)
	pfl		2.56±0.09; (2.40–2.68)		2.90±0.13; (2.61–3.05)
	bsw		2.47±0.07; (2.36–2.55)		2.75±0.08; (2.65–2.91)
	fcw		1.62±0.07; (1.50–1.73)		1.85±0.09; (1.67–2.00)
	I		0.46±0.02; (0.43–0.50)		0.48±0.02; (0.43–0.50)
Antennae	II	6	0.43±0.03; (0.40–0.47)	9	0.47±0.03; (0.40–0.53)
	III		0.75±0.03; (0.71–0.78)		0.77±0.03; (0.71–0.84)
	IV		0.90±0.06; (0.78–0.93)		0.92±0.02; (0.87–0.93)
	V	4	1.15±0.07; (1.09–1.24)	8	1.20±0.06; (1.09–1.30)
	Labium	I	10	0.65±0.03; (0.59–0.68)	9
II		1.37±0.04; (1.27–1.43)		1.41±0.04; (1.36–1.46)	
III		0.57±0.04; (0.53–0.62)		0.57±0.03; (0.53–0.62)	
IV		9		0.38±0.01; (0.37–0.40)	

Legend: tl, total length; mw, maximum width (at the sternite III level); hl, head length; cl, clypeus length; hw, head width; iod, interocellar distance; ied, interocular distance; pl, pronotum length; haw, pronotum width at the level of humeral angles; aaw, pronotum width at the level of anterolateral angles; sl, scutellum length; fil, frenal lobe length; pfl, post-frenal lobe length; bsw, basal scutellum width; fcw, scutellum width at the level of frenal constriction; I, II, III, IV and V, antennal and labium segments length.

VII concave; urosternite VII not reaching anteriorly the imaginary line connecting the spiracles of urosternite V. **Genitalia.** Pygophore with dorsal rim concave (Fig. 43A, dr) and ventral rim shallowly concave (Fig. 43B, vr). Posterolateral angles 1.4 times longer than the rest of the pygophore, base perpendicular and apex oblique to the frontal plane, convergent from the base (Fig. 43A–C, pla). Setae short on posterior half of ventral and lateral surfaces of pygophore and on outer surface of posterolateral angles; setae long on ventral rim, except on median excavation. Segment X as wide as long, not reaching the apex of the posterolateral angles; rounded, narrower at the base; basal and apical margins and mid-basal region membranous; dorsal surface covered by setae (Figs. 43A–C, X; 43J–K). Parameres falciform, flat, shorter than posterolateral angles, subparallel to the frontal plane; outer margin sinuous, distal portion strongly convex; inner margin sinuous, distal portion

strongly excavated and with an aculeiform apical process, convergent and ventrolaterally directed; apical margin convex; ventral surface with sinuous longitudinal crest (Fig. 43B and E, vcp), setae covering the region posterior to the crest (Figs. 43B, pa; 43D–G). Cup-like sclerites externally visible, apices convergent (Fig. 43B, cls). Phallus: proximal portion of vesica convex ventrally; distal portion bent ventrally; secondary gonopore ventral and beveled (Fig. 43H–I).

Female. Membrane of hemelytra not reaching the posterior margin of mediotergite VIII, posterior margin convex; median portion of posterior margin of mediotergite VIII and of urosternite VII subrectilinear, and projections urosternite VII laminate as described for *I. scutellata* (Fig. 43L–M, mpr). **Genitalia.** Valvifers VIII wider than long, posterior margin subrectilinear and slightly oblique to the median line; sutural margins subrectilinear and folded dorsally; setae on the distal half of sutural margins and on

median half of posterior margin (Figs. 5K, 43L–M, vf8). Valvifers IX almost completely covered by valvifers VIII; lateral margin convex, setae sparse on mid-basal portion of ventral surface. Laterotergites IX reaching the posterior margin of mediotergite VIII; lateral margin convex; setae on mid-basal portion of lateral and ventral surfaces (Fig. 43L–N, la9). Thickening of vaginal intima sub-hexagonal, wider than long; distal margin more sclerotized and slightly concave; median area subrectangular, membranous (Fig. 43N, vi). Vesicular area anterior to the collar 1/10 of the posterior portion; median duct with proximal widening both anterior and posterior to the collar (Fig. 43N, md, mdp); inner duct distended not coiled (Fig. 43N, id). Distal ductus receptaculi of same caliber as the proximal (Fig. 43N, drd, drp). Pars intermedialis cylindrical (Fig. 43N, pi); proximal annular crest directed to the ductus receptaculi, and about half the diameter of the distal crest, the latter perpendicular to the pars intermedialis (Fig. 43N, dac, pac). Capsula seminalis globose with two lateral filiform projections directed to the pars intermedialis, one twice longer than the other (Fig. 43N, cs, pr).

Measurements: Table 19.

Distribution. Venezuela (Bolívar), Brazil (Roraima) (Fig. 8).

Comments. See comments in *I. coralinae* sp. n. *Ischnopelta pellucidula* sp. n. differs by the longitudinal crest on the ventral surface of parameres (Fig. 43E, vcp), that is oblique or transversal in the other species of the *I. coralinae* sp. n. group (Figs. 18G, vcp; 24G, vcp; 29G, vcp; 31G, vcp; 39D, vcp; 44G, vcp).

***Ischnopelta ruckesi* Rosso & Campos, sp. n.** (Figs. 5J, 44–45)

Etymology. The epithet is in honor of Dr. Herbert Ruckes, who worked at the American Museum of Natural History (AMNH) and started, without concluding, the revision of *Ischnopelta*. He suggested in his manuscript four epithets used here to name the new species.

Type Locality. BRAZIL, *Minas Gerais*, Carmo do Rio Claro [-20.9746, -46.1134].

Holotype. Male. BRAZIL, *Minas Gerais*, Carmo do Rio Claro, I.1958, Carvalho & Becker. Deposited at the Museu de Zoologia da Universidade de São Paulo (MZSP), São Paulo (SP), Brazil.

Paratypes. 3 males and 7 females. BRAZIL, *São Paulo*, Batatais, 2 females, XII.1943, [-20.8922, -47.5901], (MCZN, Coleção Padre Pio); 1 male and 1 female, 3.I.1967, J. Moure, [-20.8922, -47.5901], (DZUP); *Minas Gerais*, São Sebastião do Paraíso, 1 male and 1 female, II.1945, Araújo, [-20.9165, -46.9861], (MZSP); 1 male, 23.II.1945, O. Monte, [-20.9165, -46.9861], (MCNZ); 1 female, 23.II.1945, O. Monte, [-20.9165, -46.9861], (MZSP); Carmo do Rio Claro, 1 female, I.1958, Carvalho & Becker, [-20.9746, -46.1134], (MZSP); *São Paulo*, Iperó, George Oeterer, 1 female, 15.XI.1961, Werner Col., [-23.4464, -47.5167], (UFRG).

Description. The overall somatic morphology is as described for *I. scutellata*, except for the following

features. Body densely punctured, brownish. Head. Labrum inserted anteriorly to half the distance between the anterior margin of the eyes and the apex of mandibular plates. Antennae dark yellowish, slightly darker ventrally and with minute punctures on segments II and II; segments ratio: I<II<III<IV<V.

Thorax. Hemelytra: corium as long as scutellum; conspicuous spot at apex of the radial vein. Pro-, meso- and metapleura dark yellowish, densely punctured on the laterals. Evaporatorium not reaching the lateral margin of mesopleura. Setae on posterodorsal margin of protibiae as long as the others.

Abdomen. Urosternite VII unarmed.

Male. Apical margin of membrane of hemelytra convex. Median portion of posterior margin of urosternite VII concave; urosternite VII not reaching anteriorly the imaginary line connecting the spiracles of urosternite V. **Genitalia.** Pygophore with dorsal rim concave and strongly sclerotized (Fig. 44C, dr); ventral rim subrectilinear with wide and shallow median depression (Fig. 44D, vr). Posterolateral angles 1.6 times longer than the rest of the pygophore, base perpendicular and apex oblique to the frontal plane, convergent from the base (Fig. 44C–E, pla). Setae short and sparse on posterior half of ventral and lateral surfaces of pygophore, and on outer surface of posterolateral angles; setae long on ventral and apical margins of posterolateral angles and ventral rim, except on the median depression. Segment X as wide as long, not reaching the apex of posterolateral angles and parameres; rounded; apical margin flat and membranous, lateral margins convex, basal margin narrow and membranous; surface sclerotized and covered by setae, denser on basal half of lateral margins (Figs. 44C–E, X; 44L–M). Parameres falciform, flat, as long as the posterolateral angles; subparallel to the frontal plane; outer margin sinuous; apical margin subrectilinear; inner margin sinuous, distal portion strongly excavated and with apical aculeiform process, convergent and ventrolaterally directed (Fig. 44D, F and G, amp); ventral surface with an oblique crest delimiting a small apical area (Fig. 44D and G, vcp), covered by setae (Figs. 44D, pa; 44F–I). Cup-like sclerites externally visible and with convergent apices (Fig. 44D, cls). Phallus: proximal 2/3 of vesica ventroposteriorly directed, base as wide as the apical margin of phalloteca, ventrally expanded and gradually narrowing; distal 1/3 sinuous, ventrally directed; secondary gonopore ventral and beveled (Fig. 44J–K).

Female. Membrane of hemelytra not reaching the posterior margin of mediotergite VIII, posterior margin convex; median portion of posterior margin of mediotergite VIII subrectilinear; median portion of posterior margin of urosternite VII concave; projections of urosternite VII as described for *I. scutellata* (Fig. 745C, mpr). **Genitalia.** Valvifers VIII wider than long; posterior margin slightly sinuous and transversal to the median line, with small projection on the lateral angle; sutural margins subrectilinear and folded dorsally; surface dark yellowish with punctures and brown blotches, and narrow and shallow longitudinal grooves; setae on the distal portion of the sutural margins and inner portion of posterior margin

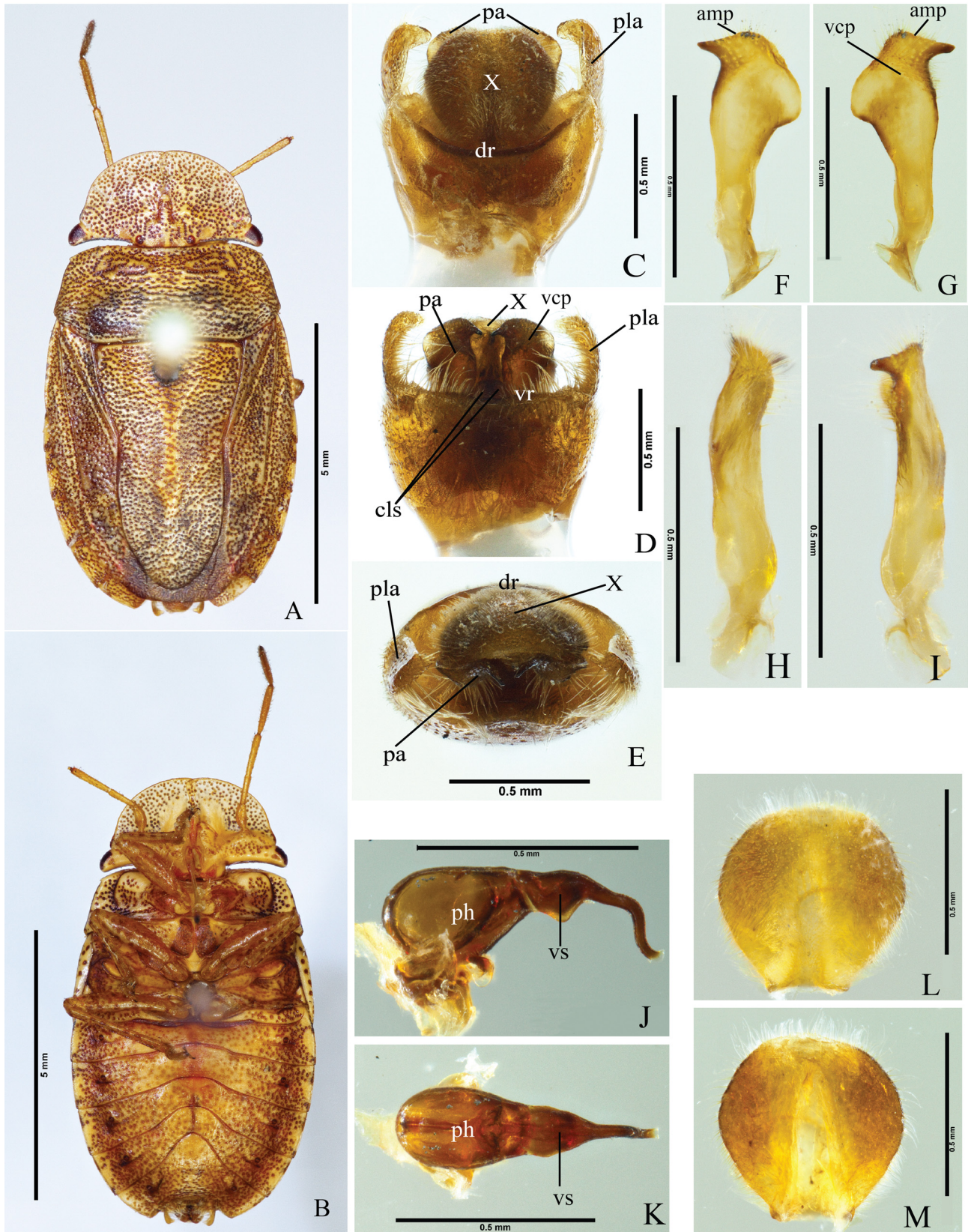

FIGURE 44. *Ischnopelta ruckesi* Rosso & Campos, sp. n. Holotype male. A, dorsal view; B, ventral view; C–E, pygophore: dorsal, ventral and posterior views respectively; F–I, parameters: dorsal, ventral, external and internal lateral views, respectively; J–K, phallus: lateral and dorsal views, respectively; L–M, segment X, dorsal and ventral views, respectively. Abbreviations: amp, apical margin; cls, cup like sclerites; dr, dorsal rim; pa, parameter; ph, phalloteca; pla, posterolateral angle; vcp, ventral crest; vr, ventral rim; vs, vesica; X, segment X.

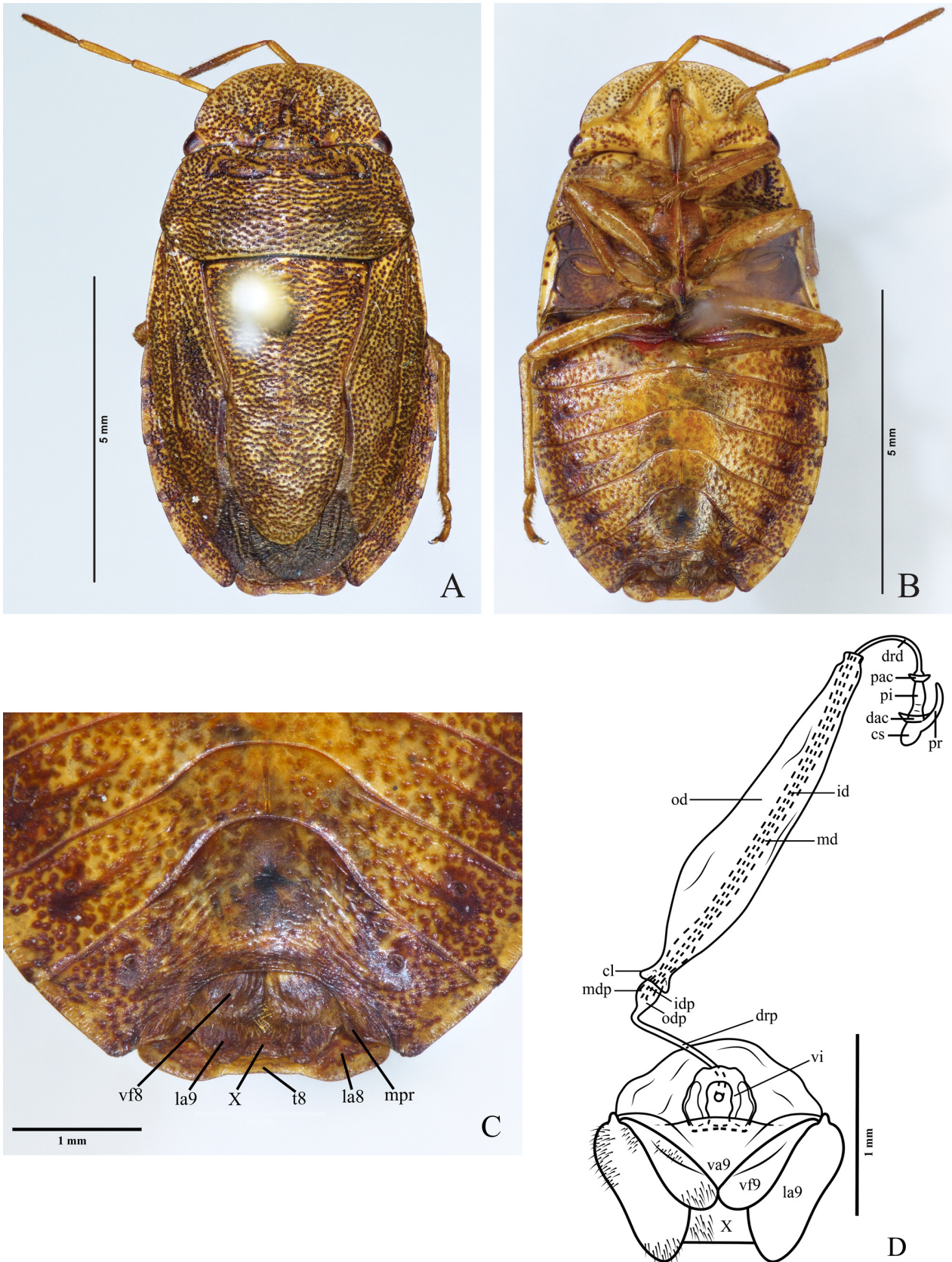

FIGURE 45. *Ischnopelta ruckesi* Rosso & Campos, sp. n. Female. A, dorsal view; B, ventral view; C, genital plates ventroposterior view (45°); D, internal genitalia. Abbreviations: cl, collar; cs, seminalis capsule; dac, distal annular crest; drd, distal ductus receptaculi; drp, proximal ductus receptaculi; id, internal duct; idp, proximal internal duct; la8, laterotergite VIII; la9, laterotergite IX; md, medium duct; mdp, proximal medium duct; mpr, projection on the lateral third of posterior margin of sternite VII; od, external duct; odp, proximal external duct; pac, proximal annular crest; pi, pars intermedialis; pr, projection; t8, mediotergite VIII; va9, valvulae IX; vf8, valvifer VIII; vf9, valvifer IX; vi, thickening of vaginal intima; X, segment X.

TABLE 20. Measurements (mean, standard deviation, minimum and maximum) and number of *Ischnopelta ruckesi* Rosso & Campos, sp. n. specimens evaluated (n).

Body structure	Measurements performed	Male		Female	
		n	Measurements (mm)	n	Measurements (mm)
Body	tl	5	7.81±0.19; (7.62–8.05)	6	8.67±0.38; (8.29–9.21)
	mw		4.56±0.09; (4.49–4.71)		4.87±0.22; (4.51–5.18)
Head	hl		1.68±0.10; (1.55–1.78)		1.75±0.13; (1.62–1.97)
	cl		0.57±0.03; (0.53–0.60)		0.61±0.03; (0.57–0.65)
	hw	5	3.36±0.12; (3.26–3.51)	6	3.53±0.20; (3.30–3.89)
	iod		0.89±0.04; (0.84–0.94)		0.95±0.05; (0.88–1.03)
	ied		2.72±0.11; (2.60–2.84)		2.84±0.23; (2.57–3.22)
	pl		1.67±0.05; (1.59–1.72)		1.81±0.06; (1.76–1.93)
Pronotum	haw	6	3.98±0.12; (3.83–4.09)	6	4.24±0.16; (4.08–4.54)
	aaw		3.34±0.14; (3.18–3.49)		3.55±0.16; (3.42–3.86)
	sl		4.30±0.23; (3.97–4.56)		4.78±0.17; (4.50–5.00)
Scutellum	fl		1.71±0.08; (1.61–1.83)		1.98±0.09; (1.90–2.09)
	pfl	6	2.60±0.17; (2.33–2.82)	7	2.80±0.12; (2.60–2.95)
	bsw		2.57±0.10; (2.43–2.69)		2.73±0.13; (2.53–2.95)
	fcw		1.79±0.09; (1.66–1.87)		1.93±0.10; (1.78–2.10)
	I		0.47±0.03; (0.43–0.50)		0.49±0.05; (0.43–0.56)
Antennae	II		0.53±0.03; (0.50–0.54)	4	0.56±0.04; (0.50–0.59)
	III	3	0.75±0.04; (0.72–0.79)		0.87±0.10; (0.76–0.99)
	IV		0.97±0.04; (0.94–1.01)		0.99±0.07; (0.90–1.05)
	V		1.27±0.08; (1.18–1.33)	3	1.27±0.04; (1.22–1.30)
	I		0.61±0.00; (0.61–0.61)		0.65±0.00; (0.65–0.65)
Labium	II	2	1.31±0.08; (1.26–1.37)	3	1.34±0.05; (1.30–1.40)
	III		0.56±0.03; (0.54–0.58)		0.59±0.02; (0.58–0.61)
	IV		0.38±0.03; (0.36–0.40)		0.41±0.02; (0.40–0.43)

Legend: tl, total length; mw, maximum width (at the sternite III level); hl, head length; cl, clypeus length; hw, head width; iod, interocellar distance; ied, interocular distance; pl, pronotum length; haw, pronotum width at the level of humeral angles; aaw, pronotum width at the level of anterolateral angles; sl, scutellum length; fl, frenal lobe length; pfl, post-frenal lobe length; bsw, basal scutellum width; fcw, scutellum width at the level of frenal constriction; I, II, III, IV and V, antennal and labium segments length.

(Figs. 5J; 45C, vf8). Valvifers IX covered; lateral margin convex, setae on mid-basal portion of ventral surface (Fig. 45D, vf9). Laterotergites IX not reaching the posterior margin of mediotergite VIII; lateral margin subrectilinear; setae on mid-basal portion of lateral margin and ventral surface (Fig. 45C–D, la9). Thickening of vaginal intima sub hexagonal, slightly wider than long; distal margin sinuous and more sclerotized; mid-basal subquadrangular area membranous (Fig. 45D, vi). Vesicular area anterior to the collar 1/10 of the posterior portion; median duct anterior to the collar with slight proximal widening (Fig. 45D, mdp), median duct posterior to the collar with proximal and distal widening (Fig. 45D, md), inner duct not coiled (Fig. 45D, id). Distal ductus receptaculi of same caliber as the proximal (Fig. 45D, drd, drp). Pars wider distally (Fig. 45D, pi); proximal annular crest perpendicular to the pars intermedialis, twice the diameter of the distal crest, this directed to the pars intermedialis

(Fig. 45D, dac, pac). Capsula seminalis globose and with a latero-basal filiform projection directed to the pars intermedialis (Fig. 45D, cs, pr).

Measurements: Table 20.

Distribution. Brazil (São Paulo, Minas Gerais) (Fig. 8).

Comments. See comments in *I. coralinae* sp. n. *Ischnopelta ruckesi* sp. n. is the only species in the *I. coralinae* group whose distal portion of the outer margin of the parameres is subrectilinear (Fig. 44F–G, amp).

***Ischnopelta vellozia* Rosso & Campos, sp. n.** (Figs. 4B, 5M, 46–47)

Etymology. The epithet refers to the Reserva Particular Vellozia, located in Serra do Cipó, component of the geological province Serra do Espinhaço, Southeast of

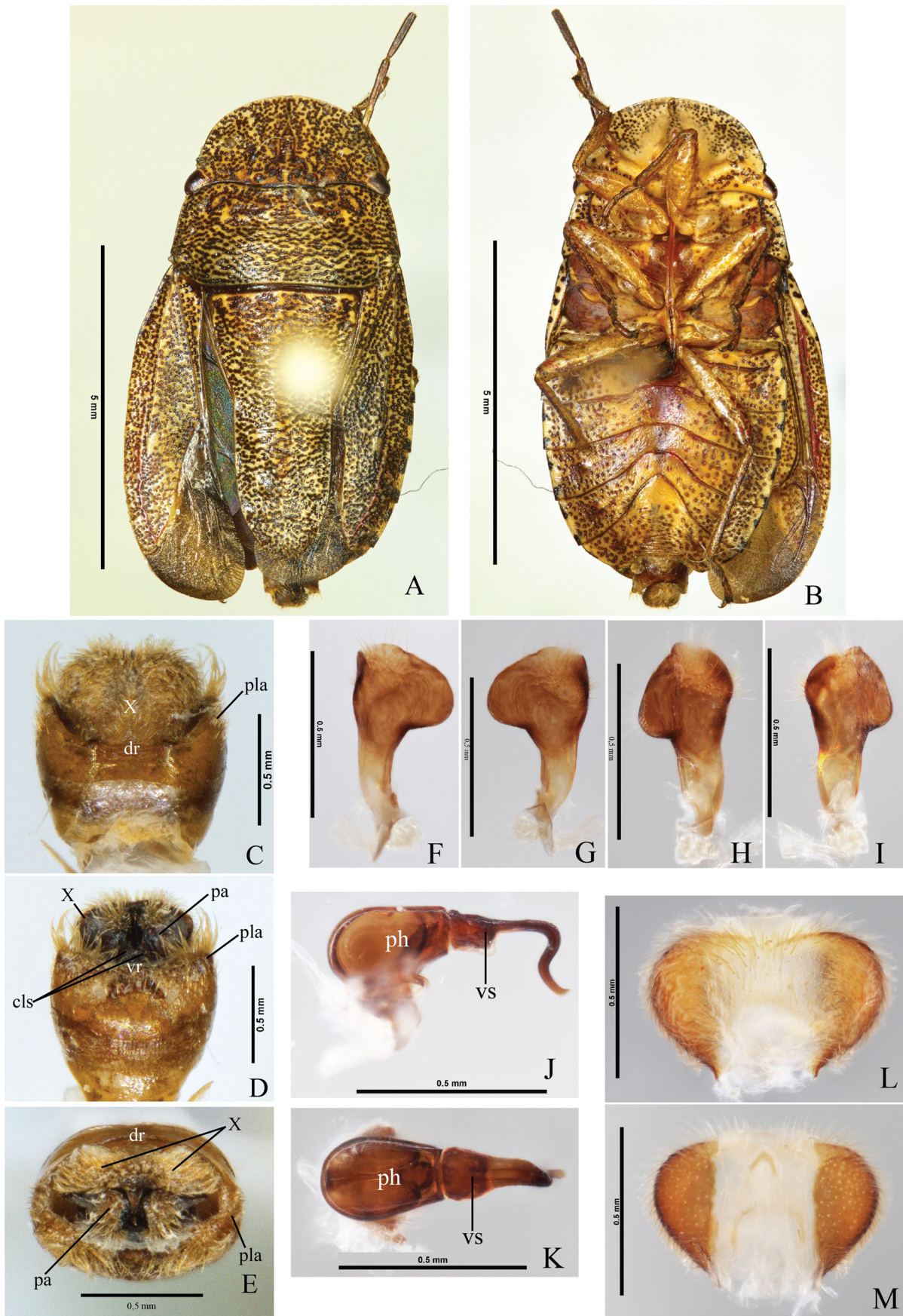

FIGURE 46. *Ischnopelta vellozia* Rosso & Campos, sp. n. Holotype male. A, dorsal view; B, ventral view; C–E, pygophore: dorsal, ventral, and posterior views respectively; F–I, parameters: dorsal, ventral, external and internal lateral views, respectively; J–K, phallus: lateral and dorsal views, respectively; L–M, segment X, dorsal and ventral views, respectively. Abbreviations: cls, cup like sclerites; dr, dorsal rim; pa, parameter; ph, phalloteca; pla, posterolateral angle; vr, ventral rim; vs, vesica; X, segment X.

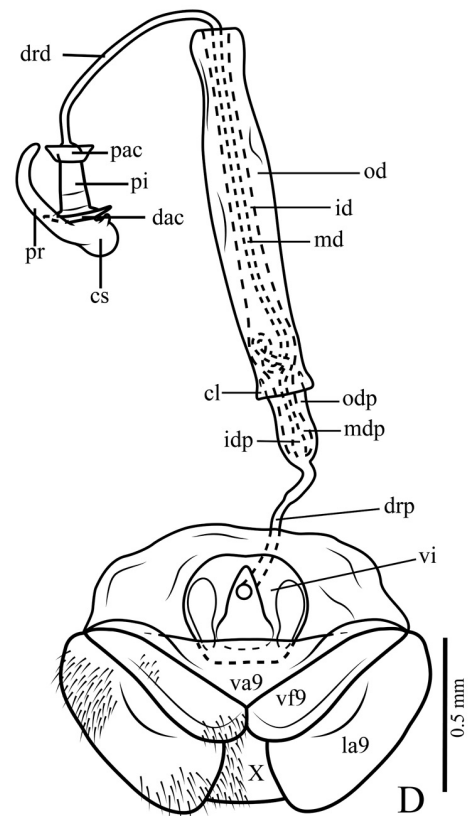
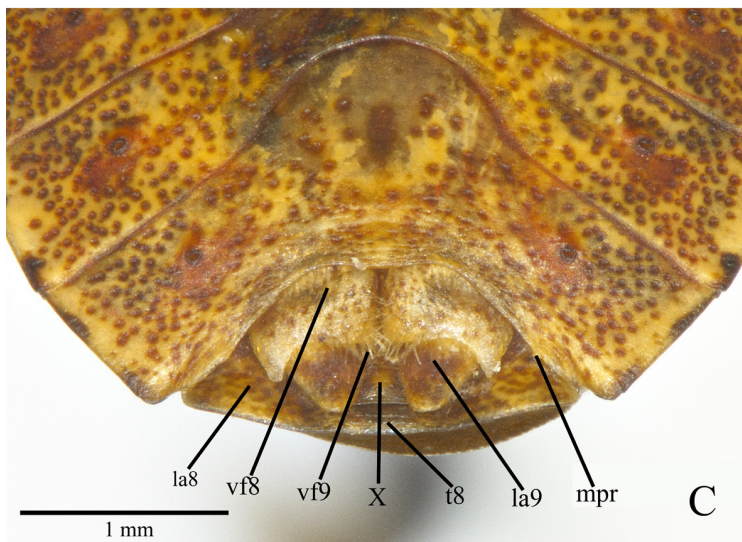
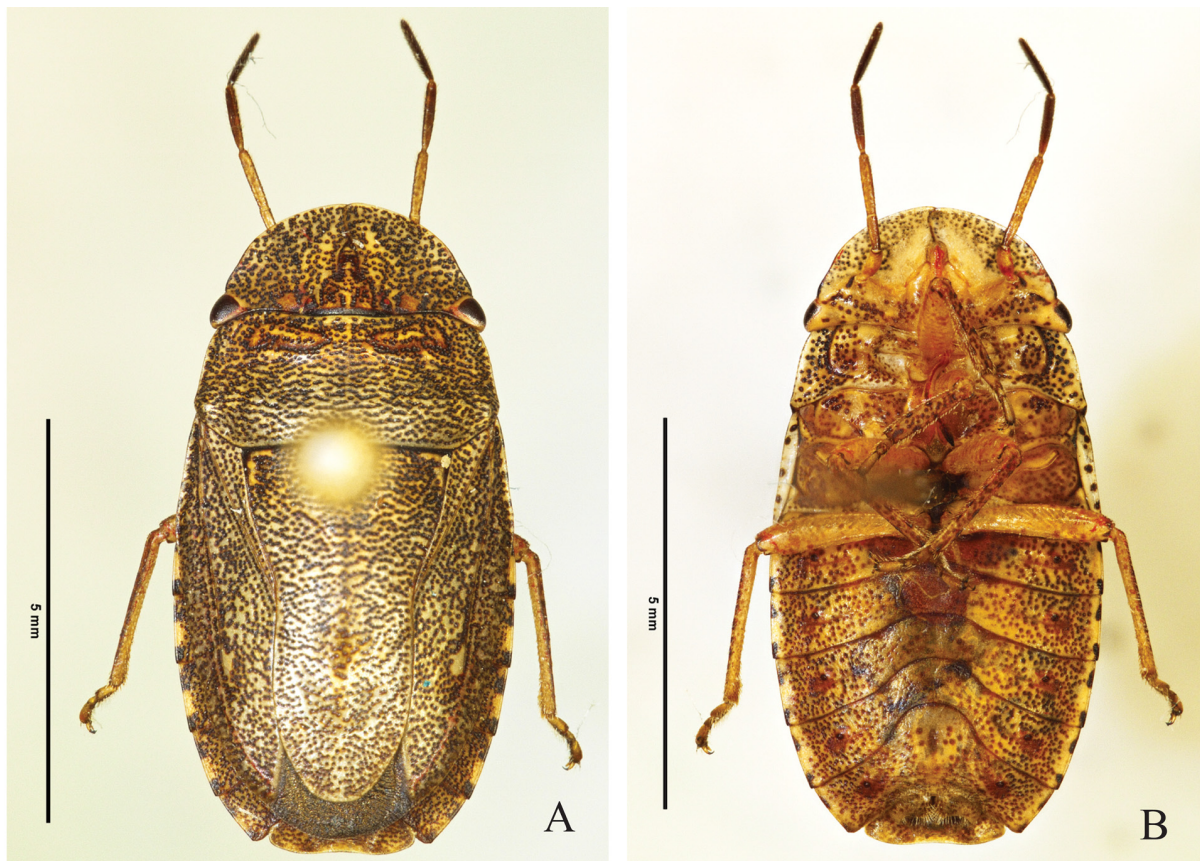

FIGURE 47. *Ischnopelta vellozia* Rosso & Campos, sp. n. Female. A, dorsal view; B, ventral view; C, genital plates ventroposterior view (45°); D, internal genitalia. Abbreviations: cl, collar; cs, seminalis capsule; dac, distal annular crest; drd, distal ductus receptaculi; drp, proximal ductus receptaculi; id, internal duct; idp, proximal internal duct; la8, laterotergite VIII; la9, laterotergite IX; md, medium duct; mdp, proximal medium duct; mpr, projection on the lateral third of posterior margin of sternite VII; od, external duct; odp, proximal external duct; pac, proximal annular crest; pi, pars intermedialis; pr, projection; t8, mediotergite VIII; va9, valvulae IX; vf8, valvifer VIII; vf9, valvifer IX; vi, thickening of vaginal intima; X, segment X.

TABLE 21. Measurements (mean, standard deviation, minimum and maximum) and number of *Ischnopelta vellozia* Rosso & Campos, sp. n. specimens evaluated (n).

Body structure	Measurements performed	Male		Female	
		n	Measurements (mm)	n	Measurements (mm)
Body	tl	6	7.07±0.30; (6.72–7.55)	4	8.24±0.10; (8.16–8.38)
	mw		3.78±0.10; (3.62–3.90)		4.39±0.07; (4.33–4.46)
Head	hl	6	1.60±0.07; (1.52–1.71)	4	1.75±0.07; (1.69–1.82)
	cl		0.53±0.03; (0.49–0.57)		0.53±0.02; (0.52–0.56)
	hw		3.09±0.09; (2.95–3.22)		3.40±0.06; (3.35–3.45)
	iod		0.87±0.03; (0.82–0.90)		0.96±0.02; (0.94–0.98)
	ied		2.45±0.08; (2.37–2.56)		2.71±0.05; (2.66–2.76)
	pl		1.49±0.05; (1.43–1.57)		1.64±0.05; (1.58–1.70)
Pronotum	haw	6	3.40±0.14; (3.23–3.61)	4	3.85±0.03; (3.82–3.89)
	aaw		3.02±0.11; (2.92–3.20)		3.31±0.02; (3.28–3.33)
	sl		3.93±0.22; (3.72–4.25)		4.44±0.07; (4.34–4.49)
Scutellum	fll	6	1.58±0.10; (1.49–1.75)	4	1.75±0.09; (1.65–1.86)
	pfl		2.35±0.15; (2.20–2.58)		2.70±0.07; (2.61–2.76)
	bsw		2.21±0.11; (2.11–2.37)		2.52±0.03; (2.49–2.57)
	fcw		1.48±0.08; (1.36–1.58)		1.68±0.04; (1.64–1.73)
	I		0.45±0.03; (0.43–0.50)		0.45±0.02; (0.43–0.47)
Antennae	II	4	0.40±0.04; (0.34–0.43)	3	0.42±0.02; (0.40–0.43)
	III		0.76±0.03; (0.71–0.78)		0.79±0.02; (0.78–0.81)
	IV		0.84±0.02; (0.84–0.87)		0.88±0.05; (0.84–0.93)
	V	3	1.13±0.04; (1.09–1.15)	1.14±0.05; (1.09–1.18)	
	Labium	I	4	0.59±0.04; (0.56–0.65)	4
II		1.26±0.05; (1.21–1.30)		1.32±0.02; (1.30–1.33)	
III		0.54±0.02; (0.53–0.56)		0.55±0.03; (0.53–0.59)	
IV		0.33±0.02; (0.31–0.34)		0.33±0.02; (0.31–0.34)	

Legend: tl, total length; mw, maximum width (at the sternite III level); hl, head length; cl, clypeus length; hw, head width; iod, interocellar distance; ied, interocular distance; pl, pronotum length; haw, pronotum width at the level of humeral angles; aaw, pronotum width at the level of anterolateral angles; sl, scutellum length; fll, frenal lobe length; pfl, post-frenal lobe length; bsw, basal scutellum width; fcw, scutellum width at the level of frenal constriction; I, II, III, IV and V, antennal and labium segments length.

Minas Gerais, Brazil, where most of the specimens used for the description of this species were collected.

Type Locality. BRAZIL, *Minas Gerais*, Santana do Riacho [-19,279444, -43,59].

Holotype. Male. Brazil, *Minas Gerais*, Santana do Riacho (RPPN Fazenda Vellozia), 29.III.2008, C. F. Schwerthner Col. Deposited at Museu de Zoologia da Universidade de São Paulo (MZSP), São Paulo (SP), Brazil.

Paratypes. 5 males and 4 females. BRAZIL, *Minas Gerais*, Diamantina (20 km NE, Rod. BR 367), 1 male, 8.I.1997, T.J. Henry & A. Paula, [-18.15, -43.502777], (USNM); Santana do Riacho (RPPN Fazenda Vellozia), 2 males and 4 females, 29.III.2008, C.F. Schwerthner Col., [-19,279444, -43,59], (UFRG); Jaboticatubas (Serra do Cipó), 2 males, 30.IV.1973, Montouchet Col., [-19.5000, -43.7500], (MZSP).

Description. The overall somatic morphology is as

described for *I. scutellata*, except for the following features. Body densely punctured, brownish. Head. Labrum inserted anteriorly to half the distance between the anterior margin of the eyes and the apex of mandibular plates. Antennae: segment I and dorsal surface of segments II and III dark yellowish with minute brown blotches, ventral surface of segments II and III light-brown, segments IV and V dark brown; segments ratio: I>II<III<IV<V.

Thorax. Hemelytra: corium as long as scutellum; conspicuous spot at apex of the radial vein blotch. Pro-, meso- and metapleura dark yellowish. . Setae on posterodorsal margin of protibiae as long as the others.

Abdomen. Dark spots at the lateral of urosternites irregularly shaped narrow; male urosternite VII unarmed.

Male. Apical margin of membrane of hemelytra convex; median portion of posterior margin of urosternite VII subrectilinear; urosternite VII not reaching anteriorly the imaginary line connecting the spiracles of urosternite V.

Genitalia. Pygophore with dorsal rim concave (Fig. 46C, dr); ventral rim sinuous with wide and shallow median depression (Fig. 46D, vr). Posterolateral angles 0.5 times shorter than the rest of the pygophore, perpendicular to the frontal plane and subparallel (Fig. 46C–E, pla). Setae in a narrow band on the ventral rim, on the median depression of ventral rim and outer surface of posterolateral angles; longer and denser on the laterals of ventral rim and apex of posterolateral angles. Segment X wider than long, surpassing the apex of posterolateral angles and dorsally covering the parameres; cordiform; apical margin sclerotized and emarginated; lateral margins sclerotized, densely covered by long setae; mid-longitudinal region membranous covered by setae, short and sparse on basal portion and longer and denser on distal portion (Figs. 46C–E, X; 46L–M). Parameres claviform, flat, oblique to the frontal plane; outer margin sinuous, distal portion strongly convex; inner margin sinuous; setae covering the distal portion of ventral surface of the head (Figs. 46D, pa; 46F–I). Cup-like sclerites externally visible, apices rounded and subparallel (Fig. 46D, cls). Phallus: vesica dorsally flat, ventrally expanded; distal portion of vesica sinuous, ventrally directed; secondary gonopore beveled (Fig. 46J–K).

Female. Membrane of hemelytra not reaching the posterior margin of mediotergite VIII, posterior margin convex; median portion of posterior margin of mediotergite VIII concave; median portion of posterior margin of urosternite VII subrectilinear; projections of urosternite VII thick and slightly oblique to the surface of urosternite VII (Fig. 47C, mpr). **Genitalia.** Valvifers VIII wider than long; posterior margin sinuous, median portion subrectilinear, lateral portion forming a subtriangular projection; sutural margins subrectilinear and folded dorsally; surface longitudinally convex, dark yellowish with brown punctures, setae on the distal portion of sutural margins and on median portion of posterior margin; longitudinal grooves narrow and shallow on basal portion (Figs. 5M; 47C, vf8). Valvifers IX partially covered by the valvifers VIII, lateral margin subrectilinear, setae on mid-basal portion of ventral surface (Fig. 47C–D, vf9). Laterotergites IX not reaching the posterior margin of mediotergite VIII; lateral margin convex; setae on mid-basal portion of lateral margin and ventral surface (Fig. 47C–D, la9). Thickening of vaginal intima slightly wider than long; proximal margin subrectilinear; distal margin convex, emarginated, and sclerotized; lateral margins convex; surface membranous on the proximal margin and on mid-longitudinal subtriangular area (Fig. 47D, vi). Vesicular area anterior to the collar 1/5 of the posterior portion; median duct anterior and posterior to the collar with proximal widening (Fig. 47D, md, mdp); inner duct coiled in the proximal widening (Fig. 47D, id). Distal ductus receptaculi of same caliber as the proximal one (Fig. 47D, drd, drp). Pars intermedialis broader distally (Fig. 47D, pi); proximal annular crest directed to the ductus receptaculi; distal annular crest perpendicular to the pars intermedialis and almost twice the diameter of the proximal one (Fig. 47D, dac, pac). Capsula seminalis globose; laterobasal projection sinuous, long; lateral projection minute (Fig. 47D, cs, pr).

Measurements: Table 21.

Distribution. Brazil (Minas Gerais) (Fig. 8).

Comments. The males of *Ischnopelta vellozia* sp. n. have a cordiform segment X (Fig. 46L–M), as in *I. anangulata* sp.n. (Fig. 13C, X), *I. cordiformis* sp. n. (Fig. 20L–M), and *I. wigodzinskyi* sp. n. (Fig. 48L–M). However, in *I. anangulata* the posterolateral angles of the pygophore are not developed (Fig. 13C–D), in *I. wigodzinskyi* they are 0.3 times the length of the pygophore (Fig. 48C, pla), whereas about 0.5 times in *I. vellozia* (Fig. 46C–D, pla) and *I. cordiformis* (Fig. 20C–D, pla). Precisely defining the identity of males on the last two species requires a more detailed analysis of the genital structures. For the females, the triangular projection on the lateral angle of valvifers VIII is larger in *I. vellozia* (Figs. 5M; 47C, vf8) than in *I. wigodzinskyi* (Fig. 5N, 49C, vf8).

***Ischnopelta wigodzinskyi* Rosso & Campos, sp. n.** (Figs. 5N, 48–49)

Etymology. Epithet probably proposed by Dr. Miriam Becker in honor of Petr Wolfgang Wygodzinsky (5.X.1916–27.I.1987), German entomologist which worked in Argentina, Brazil, and United States of America, especially with Reduviidae.

Type locality. BRAZIL, *Goiás*, Corumbá de Goiás [-15.9275, -48.8103].

Holotype. Male. BRAZIL, *Goiás*, Corumbá de Goiás, 4.II.1962, J. & B. Bechyné. Deposited at Museu Paraense Emilio Goeldi (MPEG), Belém (PA), Brazil.

Paratypes. 3 males and 9 females. BRAZIL, *Tocantins*, Palmas (Fazenda Céu, Serra do Lageado), 1 male and 1 female, XI.1992, Exp. MCN/MZSP, [-10.1669, -48.3328], (MCNZ); Dianópolis, 1 male and 1 female, 16–22.I.1962, J. Bechyné Col., [-11.6278, -46.8208], (MZSP); 1 female, 24.I.1962, J. Bechyné col., [-11.6278, -46.8208], (MPEG); *Goiás*, Minaçú (Serra da Mesa), 1 female, 19–30.XI.1996, L. Moura col., [-13.5365, -48.2212], (UFRG), Corumbá de Goiás, 1 female, 31.I.1962, J. & B. Bechyné, [-15.9275, -48.8103], (MPEG); 1 males and 4 females, 4.II.1962, J. & B. Bechyné, [-15.9275, -48.8103], (MPEG).

Description. The overall somatic morphology is as described for *I. scutellata*, except for the following features. Head. Labrum inserted anteriorly to half the distance between the anterior margin of the eyes and the apex of mandibular plates. Antennae: segment I dark yellowish; segments II and III dorsally dark yellowish and ventrally brown, segment III dorsally punctured; segments IV and V brown; segments ratio: I>II<III<IV<V.

Thorax. Hemelytra: corium as long as scutellum; conspicuous spot at apex of the radial vein.

Abdomen. Male urosternite VII unarmed.

Male. Apical margin of membrane of hemelytra convex; median portion of posterior margin of urosternite VII concave; urosternite VII not reaching anteriorly the imaginary line connecting the spiracles of sternite V. **Genitalia.** Pygophore with dorsal rim sinuous (Fig. 48C, dr) and ventral rim shallowly concave (Fig. 48D,

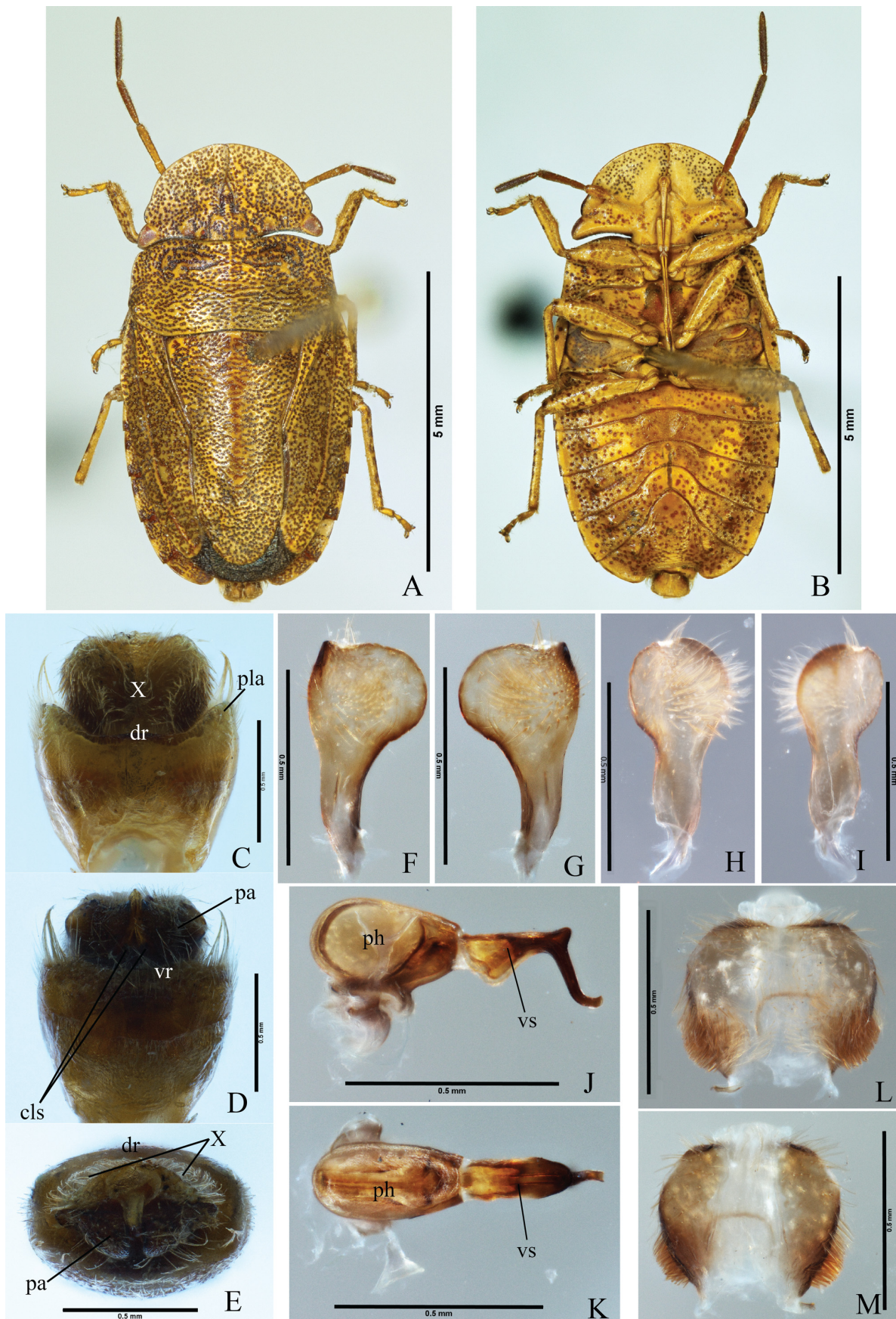

FIGURE 48. *Ischnopelta wigodzinskyi* Rosso & Campos, sp. n. Holotype male. A, dorsal view; B, ventral view; –E, pygophore: dorsal, ventral and posterior views respectively; F–I, parameters: dorsal, ventral, external and internal lateral views, respectively; J–K, phallus: lateral and dorsal views, respectively; L–M, segment X, dorsal and ventral views, respectively. Abbreviations: cls, cup like sclerites; dr, dorsal rim; pa, parameter; ph, phalloteca; pla, posterolateral angle; vr, ventral rim; vs, vesica; X, segment X.

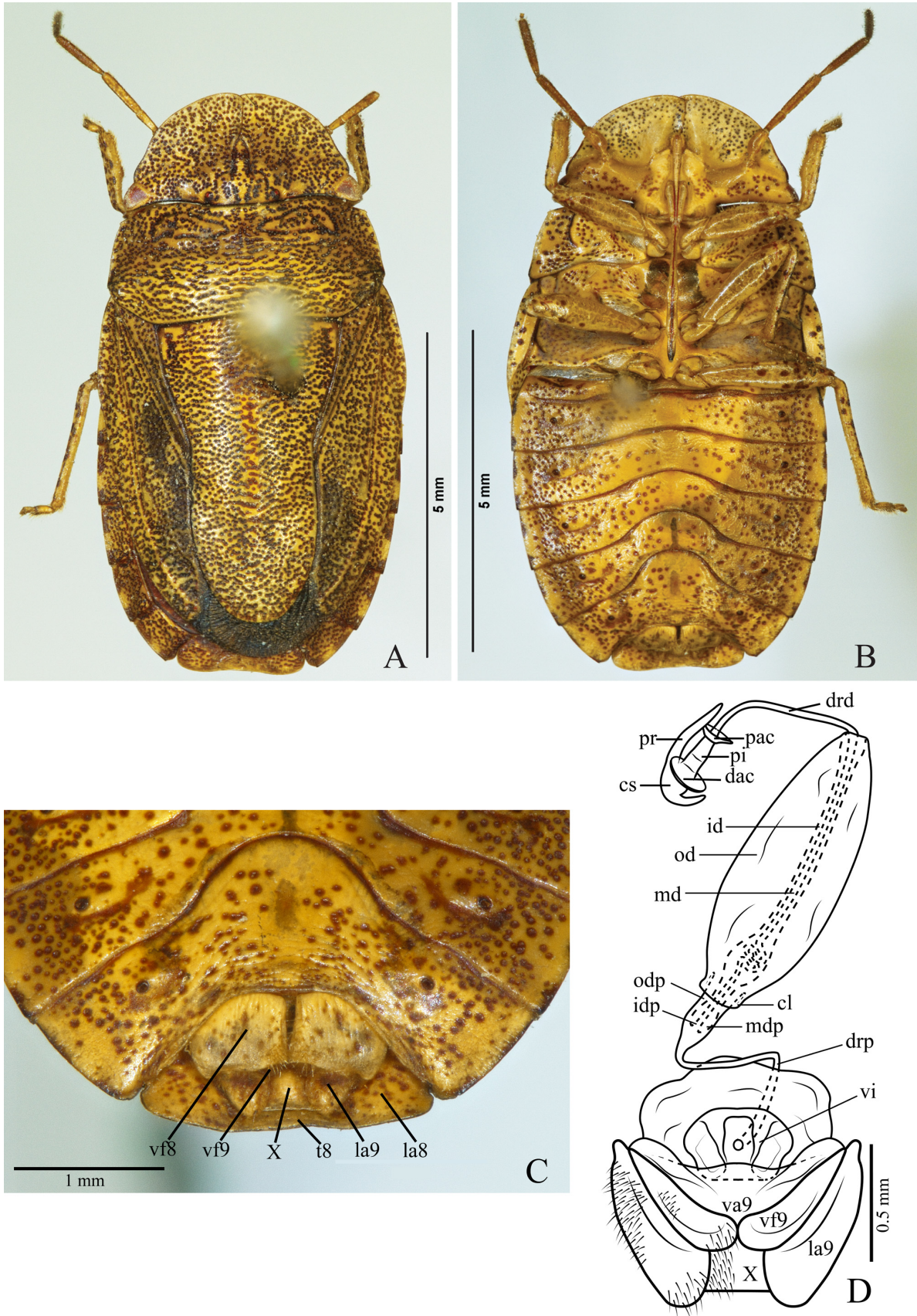

FIGURE 49. *Ischnopelta wigodzinskyi* Rosso & Campos, sp. n. Female. A, dorsal view; B, ventral view; C, genital plates ventroposterior view (45°); D, internal genitalia. Abbreviations: cl, collar; cs, seminalis capsule; dac, distal annular crest; drd, distal ductus receptaculi; drp, proximal ductus receptaculi; id, internal duct; idp, proximal internal duct; la8, laterotergite VIII; la9, laterotergite IX; md, medium duct; mdp, proximal medium duct; od, external duct; odp, proximal external duct; pac, proximal annular crest; pi, pars intermedialis; pr, projection; t8, mediotergite VIII; va9, valvulae IX; vf8, valvifer VIII; vf9, valvifer IX; vi, thickening of vaginal intima; X, segment X.

TABLE 22. Measurements (mean, standard deviation, minimum and maximum) and number of *Ischnopelta wigodzinskyi* Rosso & Campos, sp. n. specimens evaluated (n).

Body structure	Measurements performed	Male		Female	
		n	Measurements (mm)	n	Measurements (mm)
Body	tl	4	7.11±0.36; (6.74–7.51)	9	8.42±0.49; (7.89–9.14)
	mw		3.78±0.09; (3.70–3.87)		4.42±0.15; (4.21–4.62)
Head	hl	4	1.58±0.08; (1.48–1.67)	9	1.75±0.12; (1.59–1.92)
	cl		0.54±0.02; (0.51–0.57)		0.57±0.02; (0.55–0.61)
	hw		3.07±0.04; (3.04–3.13)		3.40±0.11; (3.28–3.58)
	iod		0.87±0.01; (0.86–0.88)		0.97±0.06; (0.90–1.09)
	ied		2.43±0.06; (2.35–2.50)		2.72±0.11; (2.58–2.89)
	pl		1.49±0.06; (1.41–1.54)		1.68±0.10; (1.54–1.80)
Pronotum	haw	4	3.45±0.09; (3.36–3.54)	9	3.91±0.18; (3.70–4.19)
	aaw		3.02±0.09; (2.94–3.13)		3.41±0.19; (3.18–3.70)
	sl		3.83±0.19; (3.66–4.01)		4.54±0.20; (4.18–4.78)
Scutellum	fll	4	1.55±0.11; (1.44–1.66)	9	1.83±0.12; (1.65–2.02)
	pfl		2.28±0.09; (2.20–2.39)		2.72±0.15; (2.49–2.98)
	bsw		2.22±0.07; (2.15–2.28)		2.57±0.12; (2.41–2.72)
	fcw		1.49±0.03; (1.46–1.52)		1.79±0.06; (1.70–1.87)
	I		0.42±0.02; (0.40–0.43)		0.43±0.03; (0.40–0.47)
Antennae	II	4	0.37±0.03; (0.34–0.40)	9	0.39±0.03; (0.34–0.43)
	III		0.73±0.02; (0.71–0.74)		0.77±0.04; (0.71–0.84)
	IV		0.77±0.04; (0.71–0.81)		0.88±0.02; (0.84–0.90)
	V		1.11±0.03; (1.09–1.15)		1.16±0.04; (1.12–1.21)
	I		0.59±0.00; (0.59–0.59)		0.64±0.02; (0.62–0.65)
Labium	II	4	1.33±0.02; (1.30–1.33)	9	1.36±0.03; (1.33–1.40)
	III		0.49±0.02; (0.47–0.50)		0.53±0.02; (0.50–0.56)
	IV		0.34±0.00; (0.34–0.34)		0.36±0.01; (0.34–0.37)

Legend: tl, total length; mw, maximum width (at the sternite III level); hl, head length; cl, clypeus length; hw, head width; iod, interocellar distance; ied, interocular distance; pl, pronotum length; haw, pronotum width at the level of humeral angles; aaw, pronotum width at the level of anterolateral angles; sl, scutellum length; fll, frenal lobe length; pfl, post-frenal lobe length; bsw, basal scutellum width; fcw, scutellum width at the level of frenal constriction; I, II, III, IV and V, antennal and labium segments length.

vr). Posterolateral angles 0.3 times shorter than the rest of the pygophore, perpendicular to the frontal plane and subparallel (Fig. 48C–E, pla). Setae short in a band on the ventral rim and outer surface of the posterolateral angles; 1 + 1 tufts of long setae on apices of posterolateral angles. Segment X wider than long, surpassing the apex of parameres and posterolateral angles; cordiform; laterobasal surface more sclerotized and densely covered by setae, apical margin sclerotized, emarginated and covered by setae; mid-longitudinal region membranous (Figs. 48C and E, X; 48L–M). Parameres spatulate, flat, oblique to the frontal plane; outer margin sinuous, distal portion strongly convex; inner margin sinuous; apical margin sinuous and forming a minute process on the inner margin; apical portion covered by setae (Figs. 48D–E, pa; 48F–I). Cup-like sclerites externally visible ad with divergent apices (Fig. 48D, cls). Phallus: proximal portion of vesica almost as wide as distal margin of phallosome,

ventrally and dorsoposteriorly expanded; distal portion subcylindrical and ventrally directed; apical portion posteriorly directed; secondary gonopore beveled (Fig. 48J–K).

Female. Membrane of hemelytra not reaching the posterior margin of mediotergite VIII, posterior margin convex; median portion of posterior margin of mediotergite VIII and median portion of posterior margin of urosternite VII subrectilinear; projections on the lateral 1/3 of posterior margin of urosternite VII absent.

Genitalia. Valvifers VIII wider than long; posterior margin sinuous with a triangular projection at the lateral angle; sutural margins subrectilinear and folded dorsally; surface dark yellowish with brown punctures, setae on the sutural margins and on median portion of the posterior margin; longitudinal grooves narrow and shallow on basal portion (Figs. 5N; 49C, vf8). Valvifers IX covered by the valvifers VIII, lateral margin subrectilinear, setae

on mid-basal portion of ventral surface (Fig. 49C–D, vf9). Laterotergites IX not reaching the posterior margin of mediotergite VIII; lateral margin convex; setae on mid-basal portion of lateral margin and ventral surface (Fig. 49C–D, la9). Thickening of vaginal intima sub hexagonal, wider than long; distal margin weakly emarginated; laterals weakly sclerotized; median subrectangular area membranous (Fig. 49D, vi). Vesicular area anterior to the collar 1/7 of the posterior portion; median duct anterior to the collar with slight proximal widening (Fig. 49D, mdp); median duct posterior to the collar with proximal and distal widening (Fig. 49D, md); inner duct coiled in the proximal widening (Fig. 49D, id). Distal ductus receptaculi of same caliber as the proximal (Fig. 49D, drd, drp). Pars intermedialis broader distally (Fig. 49D, pi); proximal annular crest directed to the ductus receptaculi; distal annular crest perpendicular to the pars intermedialis (Fig. 49D, dac, pac). Capsula seminalis globose; long and sinuous laterobasal projection surpassing the proximal annular crest; laterodistal projection short (Fig. 49D, cs, pr).

Measurements: Table 22.

Distribution. Brazil (Tocantins, Goiás) (Fig. 8).

Comments. See comments in *I. vellozia* sp. n.. The segment X on males of *Ischnopelta wigodizinkyi* sp. n., although cordiform, has the apical margin less emarginated, and the setae denser on the laterobasal margins (Fig. 48L–M).

References

- Baker, A.D. (1931) A study of the male genitalia of Canadian species of Pentatomidae. *Canadian Journal of Research*, 4, 148–220.
<https://doi.org/10.1139/cjr31-013>
- Barão, K.R., Ferrari, A., Adami, C.V.K. & Grazia, J. (2016) Diversity of the external thoracic scent efferent system of Carpororini (Heteroptera: Pentatomidae) with character selection for phylogenetic inference. *Zoologischer Anzeiger*.
<https://doi.org/10.1016/j.jcz.2016.08.003>
- Becker, M. (1977) A review of the genus *Colpocarena* Stål (Heteroptera, Pentatomidae, Discocephalinae). *Revista Brasileira de Biologia*, 37, 367–373.
- Becker, M. & Grazia, J. (1992) Revisão do gênero *Discocephala* Laporte (Heteroptera, Pentatomidae, Discocephalinae). *Anais da Sociedade Entomológica do Brasil*, 21 (2), 201–215.
<https://doi.org/10.37486/0301-8059.v21i2.782>
- Becker, M. & Grazia, J. (1995) The bug genus *Uncinula* Ruckes, 1965 (Heteroptera, Pentatomidae, Discocephalinae). *Revista Brasileira de Entomologia*, 39 (3), 709–716.
- Berg, C. (1891) Nova Hemiptera faunarum argentinae et uruguayensis. *Anales de la Sociedad Científica Argentina*, 32, 231–243.
- Dupuis, C. (1970) Heteroptera. In: Tuxen, S.L. (Ed.), *Taxonomist's Glossary of Genitalia of Insects*. Copenhagen, Munksgaard, pp. 190–208.
- Fieber, F.X. (1851) Rhynchotographien. Drei monographische Abhandlungen. *Acten der Königlichen Böhmischen Gesellschaft der Wissenschaften*, 7 (5), 427–488.
- Fieber, F.X. (1860) *Die europäischen. Hemiptera. Halbflüger (Rinchota Heteroptera). Nach der analytischen Methode bearbeitet*. Carl Gerold's Sohn, Wien, 444 pp.
<https://doi.org/10.5962/bhl.title.47533>
- Garbelotto, T.A. (2015) *Filogenia e classificação de Discocephalini (Hemiptera: Pentatomidae: Discocephalinae)* (Tese). Programa de Pós-Graduação em Biologia Animal, Instituto de Biociências, Universidade Federal do Rio Grande do Sul.
- Garbelotto, T.A., Campos, L.A. & Grazia, J. (2013) Cladistics and revision of *Alitocoris* with considerations on the phylogeny of the *Herrichella* clade (Hemiptera, Pentatomidae, Discocephalinae, Ochlerini). *Zoological Journal of the Linnean Society*, 168 (3), 452–472.
<https://doi.org/10.1111/zoj.12032>
- Garbelotto, T.A., Kochenborger, A.P.L. & Campos, L.A. (2018) Revision of *Lineostethus* (Heteroptera: Pentatomidae: Discocephalini). *Zoologia (Curitiba)*. 35, e21232. Epub Nov 14, 2018.
<https://doi.org/10.3897/zoologia.35.e21232>
- Grazia, J., Fortes, N.D.F. & Campos, L.A. (1999) Pentatomoidea. In: Brandão, C.R. & Cancellato, E.M. (Eds.), *Biodiversidade do Estado de São Paulo, Brasil: síntese do conhecimento ao final do século XX – Invertebrados terrestres*. FAPESP, São Paulo, v. 5, pp. 101–112.
- Grazia, J. & Schwertner, C.F. (2011) Checklist dos percevejos-domato (Hemiptera: Heteroptera: Pentatomoidea) do Estado de São Paulo, Brasil. *Biota Neotropica*, 11 (1a), 705–716.
<https://doi.org/10.1590/S1676-06032011000500034>
- Grazia, J., Panizzi, A.R., Greve, C., Schwertner, C.F., Campos, L.A., Garbelotto, T.A. & Fernandes, J.A.M. (2015) Stink Bugs (Pentatomidae). In: Panizzi, A.R. & Grazia, J. (Eds.), *True Bugs (Heteroptera) of the Neotropics*. Springer Netherlands, Dordrecht, pp. 681–756.
https://doi.org/10.1007/978-94-017-9861-7_22
- Kirkaldy, G.W. (1909) *Catalogue of the Hemiptera (Heteroptera) v. I: Cimicidae*. Felix L. Dames, Berlin, 392 pp.
- Kment, P. & Vilímová, J. (2010) Thoracic scent efferent system of Pentatomoidea (Hemiptera: Heteroptera): a review of terminology. *Zootaxa*, 2706, 1–77.
<https://doi.org/10.11646/zootaxa.2706.1.1>
- Lethierry, L. & Severin, G. (1893) *Catalogue Général des Hémiptères: Hétéroptères: Pentatomidae*. Musée Royal d'Histoire Naturelle de Belgique, Bruxelles, I, 286 pp.
- Micro-Shot Technology Co. (2010) MShot Digital Imaging System, version 1.1.
- Rider, D.A., Schwertner, C.F., Vilímová, J., Rédei, D., Kment, P. & Thomas, D.B. (2018) Higher Systematics of the Pentatomoidea. In: McPherson (Ed.), *Invasive stink bugs and related species (Pentatomoidea): biology, higher systematics, semiochemistry, and management*. Boca Raton: Taylor & Francis, pp. 25–201.
<https://doi.org/10.1201/9781315371221-2>
- Roell, T. & Campos, L.A. (2015) *Candecoris bistillatus*, new genus and new species of Ochlerini from Ecuador (Hemiptera: Heteroptera: Pentatomidae). *Zootaxa*, 4018 (4), 573–583.
<https://doi.org/10.11646/zootaxa.4018.4.6>
- Roell, T. & Campos, L.A. (2019) Phylogeny of Ochlerini (Hemiptera: Pentatomidae: Discocephalinae) and the evolution of the apical tarsomere in hind legs. *Zoological Journal of the Linnean Society*, 185 (4), 1137–1149.

<https://doi.org/10.1093/zoolinnean/zly073>

- Rohlf, F.J. (2010) tpsDig, version 2.16. Department of Ecology and Evolution, State University of New York at Stony Brook: New York. Available from: <http://life.bio.sunysb.edu/morph/> (accessed 30 November 2013)
- Rolston, L.H. (1981) Ochlerini, a new tribe in Discocephalinae (Hemiptera: Pentatomidae). *Journal of the New York Entomological Society*, 89, 40–42.
- Rolston, L.H. (1990) Key and diagnoses for the genera of ‘broaheaded’ discocephalines (Hemiptera: Pentatomidae). *Journal of the New York Entomological Society*, 98, 14–31
- Rolston, L.H. & McDonald, F.J.D. (1979) Keys and diagnoses for the families of Western Hemisphere Pentatomoidea, subfamilies of Pentatomidae and tribes of Pentatominae (Hemiptera). *Journal of the New York Entomological Society*, 87 (3), 189–207.
- Rosso, P. & Campos, L.A. (2017a) *Nigrisagitta distichus*, a new genus and species of Discocephalini from Venezuela (Hemiptera, Pentatomidae, Discocephalinae). *Zootaxa*, 4303 (3), 427–536.
<https://doi.org/10.11646/zootaxa.4303.3.8>
- Rosso, P. & Campos, L.A. (2017b) Erratum. *Nigrisagitta distichus*, a new genus and of Discocephalini from Venezuela (Hemiptera, Pentatomidae, Discocephalinae) *Zootaxa*, 4303 (4), 427–436.
<https://doi.org/10.11646/zootaxa.4323.4.13>
- Ruckes, H. (1966) An analysis and a breakdown of the genus *Platycarenum* Fieber (Heteroptera, Pentatomidae, Discocephalinae). *American Museum Novitates*, 2255, 1–42.
- Schuh, R.T. & Slater, J.A. (1995) *True bugs of the world (Hemiptera: Heteroptera): classification and natural history*. Cornell University Press, Ithaca, 336 pp.
- Signoret, M.V. (1851) Description de Nouvelles Espèces d’Hémiptères. *Annales de la Société Entomologique de France*, 9 (2), 329–348.
- Stål, C. (1868) Hemiptera Fabriciana. Fabricianska Hemipterarter, efter de i Köpenhamn och Kiel förvarade typexemplaren granskade och beskrifne. *Kongliga Svenska Vetenskaps Academiens Nya Handlingar*, 7 (11, 1), 1–148.
- Stål, C. (1872) Enumeratio hemipterorum: bidrag till en förteckning öfver alla hittills kända hemiptera, jemte systematiska meddelanden. *Kongliga Svenska Vetenskaps Academiens Nya Handlingar*, 10 (4, 2), 1–159.
<https://doi.org/10.5962/bhl.title.12549>
- Walker, F. (1867) *Catalogue of the specimens of Heteropterous Hemiptera in the collection of the British Museum*. British Museum, London, I, 240 pp.
<https://doi.org/10.5962/bhl.title.118688>
- Zhou, Y. & Rédei, D. (2020) From lanceolate to plate-like: Gross morphology, terminology, and evolutionary trends of the trichophoran ovipositor. *Arthropod Structure & Development*, 54, 1–29.
<https://doi.org/10.1016/j.asd.2020.100914>